

Electric Airless Sprayers

3A9095D

EN

For portable airless spraying of architectural paints and coatings. For professional use only. Not approved for use in explosive atmospheres or hazardous (classified) locations.

Models: 490 XT, 495 XT, 650 XT

3300 psi (228 bar, 22.8 MPa) Maximum Working Pressure

See page 4 for model information, including approvals



Important Safety Instructions

Read all warnings and instructions in this manual, in related manuals, and on the power cord before using the equipment. Be familiar with the controls and the proper usage of the equipment. Save these instructions.

Related Manuals	Description
3A6285	Gun (Contractor PC)
334599	Pump

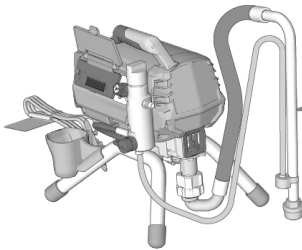

Ultra 490 XT

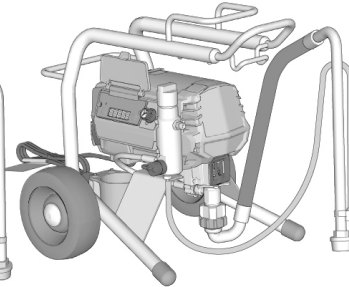

Ultra 495 XT

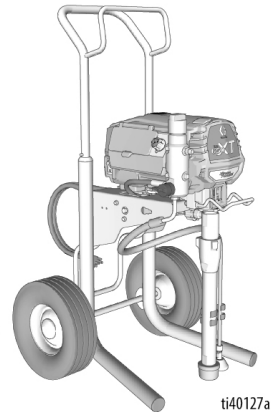

Ultra 650 XT

ti40127a



Use only genuine Graco replacement parts.
The use of non-Graco replacement parts may void warranty.

Contents

Translated Manuals	3
Models	4
Warnings	5
Component Identification	9
Stand Models	9
Lo-Boy Models	10
Hi-Boy Models	11
Controls and Display	12
Grounding	13
Extension Cords	13
Pails	13
Pressure Relief Procedure	14
Setup	16
Startup	19
Operation	21
Spray Tip Installation	21
Performance Modes	21
Spray	22
Clear Spray Tip Clog	23
Cleanup	23
Digital Display	26
Operation Main Menu	26
Selecting Performance Modes	27
TurboClean	27
Watchdog	27
Stored Data Display	28
Knob Calibration	29
Transducer Calibration	29
BlueLink® App	30
Maintenance	31
Recycling and Disposal at End of Life	31
Troubleshooting	32
Mechanical/Fluid Flow	32
Electrical	34
Control Board	35
Motor	36
Parts	38
Accessories and Labels	48
Wiring Diagrams	49
Technical Specifications	52
California Proposition 65	53
Graco Standard Warranty	54
Graco Information	55

Translated Manuals

Digital versions of translated manuals for this product can be found online at www.graco.com, or by scanning the QR code listed under Link to Languages below. Available translations and their respective Graco manual numbers are listed here for reference.







Bulgarian	3A9137	Korean	3A9158
Chinese	3A9156	Latvian	3A9134
Croatian	3A9141	Lithuanian	3A9135
Czech	3A9142	Norwegian	3A9136
Danish	3A9143	Polish	3A9133
Dutch	3A9140	Portuguese	3A9130
English	3A9095	Romanian	3A9131
Estonian	3A9138	Slovakian	3A9144
Finnish	3A9139	Slovenian	3A9145
French	3A9155	Spanish	3A9154
German	3A9149	Swedish	3A9150
Greek	3A9146	Turkish	3A9153
Hungarian	3A9147		
Japanese	3A9157		

Link to Languages

To locate translated manuals online, scan the QR code and find the appropriate manual on the web page which appears.



Models

Approval Mark	Electrical Ratings and Regions	Model	Stand 	Lo-Boy 	Hi-Boy 
	110-120 V 50-60 Hz North America	Ultimate™ 490 XT	826284	826285	826286
		Ultra® 490 XT	19D519	19D520	19D521
		Ultimate 495 XT	826287	826288	826289
		Ultra 495 XT	19D522	19D523	19D524
		Ultimate 650 XT		826293	826294
		Ultra 650 XT		20B304	20B305
	220-240 V 50-60 Hz EMEA CEE 7/7	Ultra 490 XT	19D525		19D526
		Ultra 495 XT	19D527		19D528
		Ultra 650 XT			20B308
	100-120 V 50-60 Hz UK CEEFORM	Ultra 495 XT	19D529		19D530
		Ultra 650 XT			20B311
	220-240 V 50-60 Hz Australia, New Zealand	Ultra 490 XT	19D531		
		Ultra 495 XT	19D532	19D534	19D533
		Ultra 650 XT		20B327	20B328
	100-120 V 50-60 Hz Japan, Taiwan	Ultra 490 XT	19D535		
		Ultra 495 XT	19D536		

Warnings

The following warnings are for the setup, use, grounding, maintenance, and repair of this equipment. The exclamation point symbol alerts you to a general warning and the hazard symbols refer to procedure-specific risks. When these symbols appear in the body of this manual or on warning labels, refer back to these Warnings. Product-specific hazard symbols and warnings not covered in this section may appear throughout the body of this manual where applicable.

WARNING



GROUNDING

This product must be grounded. In the event of an electrical short circuit, grounding reduces the risk of electric shock by providing an escape wire for the electric current. This product is equipped with a cord having a grounding wire with an appropriate grounding plug. The plug must be plugged into an outlet that is properly installed and grounded in accordance with all local codes and regulations.

- Improper installation of the grounding plug is able to result in a risk of electric shock.
- When repair or replacement of the cord or plug is required, do not connect the grounding wire to either power terminal.
- The wire with insulation having an outer surface that is green with or without yellow stripes is the grounding wire.
- Check with a qualified electrician or serviceman when the grounding instructions are not completely understood, or when in doubt as to whether the product is properly grounded.
- Do not modify the plug provided. If it does not fit the outlet, have the proper outlet installed by a qualified electrician.
- This product is for use on a nominal 120 V or 230 V circuit and has a grounding plug similar to the plugs illustrated in the figure below.

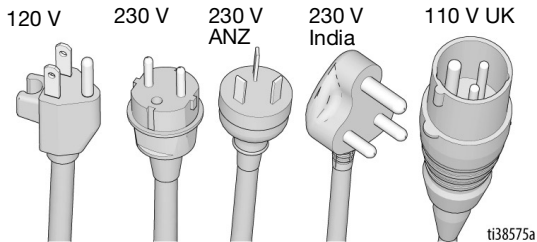

- Only connect the product to an outlet having the same configuration as the plug.
- Do not use a 3-to-2 adapter with this product.

Extension Cords:

- Use only a 3-wire extension cord that has a grounding plug and a grounding receptacle that accepts the plug on the product.
- Make sure your extension cord is not damaged.
- If an extension cord is necessary, use 12 AWG (2.5 mm²) minimum to carry the current that the product draws.
- An undersized cord results in a drop in line voltage and loss of power and overheating.

WARNING



FIRE AND EXPLOSION HAZARD

Flammable fumes, such as solvent and paint fumes, in work area can ignite or explode. To help prevent fire and explosion:



- Do not spray flammable or combustible materials near an open flame or sources of ignition such as cigarettes, motors, and electrical equipment.



- Paint or solvent flowing through the equipment is able to result in static electricity. Static electricity creates a risk of fire or explosion in the presence of paint or solvent fumes. All parts of the spray system, including the pump, hose assembly, spray gun, and objects in and around the spray area shall be properly grounded to protect against static discharge and sparks. Use Graco conductive or grounded high-pressure airless paint sprayer hoses.



- Verify that all containers and collection systems are grounded to prevent static discharge. Do not use pail liners unless they are anti-static or conductive.
- Connect to a grounded outlet and use grounded extensions cords. Do not use a 3-to-2 adapter.
- Do not use a paint or a solvent containing halogenated hydrocarbons.
- Keep spray area well-ventilated. Keep a good supply of fresh air moving through the area.
- Sprayer generates sparks. Keep pump assembly in a well-ventilated area at least 20 feet (6.1 m) from the spray area when spraying, flushing, cleaning, or servicing. Do not spray pump assembly.
- Do not smoke in the spray area or spray where sparks or flame is present.
- Do not operate light switches, engines, or similar spark producing products in the spray area.
- Do not plug or unplug power cords when flammable fumes are present.
- Keep area clean and free of paint or solvent containers, rags, and other flammable materials.
- Know the contents of the paints and solvents being sprayed. Read all Safety Data Sheets (SDSs) and container labels provided with the paints and solvents. Follow the paint and solvent manufacturer's safety instructions.
- Keep a working fire extinguisher in the work area.
- **Stop operation immediately** if static sparking occurs or you feel a shock. Do not use equipment until you identify and correct the problem.

WARNING

SKIN INJECTION HAZARD



High-pressure spray is able to inject toxins into the body and cause serious bodily injury that can result in amputation. In the event that injection occurs, **get immediate surgical treatment.**



- Do not aim the gun at, or spray any person or animal.
- Keep hands and other body parts away from the discharge. For example, do not try to stop leaks with any part of the body.
- Always use the spray tip guard. Do not spray without spray tip guard in place.
- Use Graco spray tips.
- Use caution when cleaning and changing spray tips. In the case where the spray tip clogs while spraying, follow the **Pressure Relief Procedure** for turning off the unit and relieving the pressure before removing the spray tip to clean.
- Equipment maintains pressure after power is shut off. Do not leave the equipment energized or under pressure while unattended. Follow the **Pressure Relief Procedure** when the equipment is unattended or not in use, and before servicing, cleaning, or removing parts.
- Check hoses and parts for signs of damage. Replace any damaged hoses or parts.
- This system is capable of producing 3300 psi. Use Graco replacement parts or accessories that are rated a minimum of 3300 psi.
- Always engage the trigger lock when not spraying. Verify the trigger lock is functioning properly.
- Verify that all connections are secure before operating the unit.
- Know how to stop the unit and bleed pressure quickly. Be thoroughly familiar with the controls.



EQUIPMENT MISUSE HAZARD



Misuse can cause death or serious injury.

- Always wear appropriate gloves, eye protection, and a respirator or mask when painting.
- Do not operate or spray near children. Keep children away from equipment at all times.
- Do not overreach or stand on an unstable support. Keep effective footing and balance at all times.
- Stay alert and watch what you are doing.
- Do not operate the unit when fatigued or under the influence of drugs or alcohol.
- Do not kink or over-bend the hose.
- Do not expose the hose to temperatures or to pressures in excess of those specified by Graco.
- Do not use the hose as a strength member to pull or lift the equipment.
- Do not spray with a hose shorter than 25 feet (7.6 m).
- Do not alter or modify equipment. Alterations or modifications may void agency approvals and create safety hazards.
- Make sure all equipment is rated and approved for the environment in which you are using it.

Warnings

WARNING



ELECTRIC SHOCK HAZARD

This equipment must be grounded. Improper grounding, setup, or usage of the system can cause electric shock.



- Turn off and disconnect power cord before servicing equipment.
- Connect only to grounded electrical outlets.
- Use only 3-wire extension cords.
- Ensure ground prongs are intact on power and extension cords.
- Do not expose to rain. Store indoors.
- Wait five minutes after disconnecting power cord before servicing.
- Only use an authorized service center to replace a damaged power cord.



PRESSURIZED ALUMINUM PARTS HAZARD

Use of fluids that are incompatible with aluminum in pressurized equipment can cause serious chemical reaction and equipment rupture. Failure to follow this warning can result in death, serious injury, or property damage.

- Do not use 1,1,1-trichloroethane, methylene chloride, other halogenated hydrocarbon solvents or fluids containing such solvents.
- Do not use chlorine bleach.
- Many other fluids may contain chemicals that can react with aluminum. Contact your material supplier for compatibility.



MOVING PARTS HAZARD

Moving parts can pinch, cut or amputate fingers and other body parts.



- Keep clear of moving parts.
- Do not operate equipment with protective guards or covers removed.
- Equipment can start without warning. Before checking, moving, or servicing equipment, follow the **Pressure Relief Procedure** and disconnect all power sources.



TOXIC FLUID OR FUMES HAZARD

Toxic fluids or fumes can cause serious injury or death if splashed in the eyes or on skin, inhaled, or swallowed.

- Read Safety Data Sheets (SDSs) to know the specific hazards of the fluids you are using.
- Store hazardous fluid in approved containers, and dispose of it according to applicable guidelines.



PERSONAL PROTECTIVE EQUIPMENT

Wear appropriate protective equipment when in the work area to help prevent serious injury, including eye injury, hearing loss, inhalation of toxic fumes, and burns. This protective equipment includes but is not limited to:

- Protective eyewear, and hearing protection.
- Respirators, protective clothing, and gloves as recommended by the fluid and solvent manufacturer.

Component Identification

Stand Models

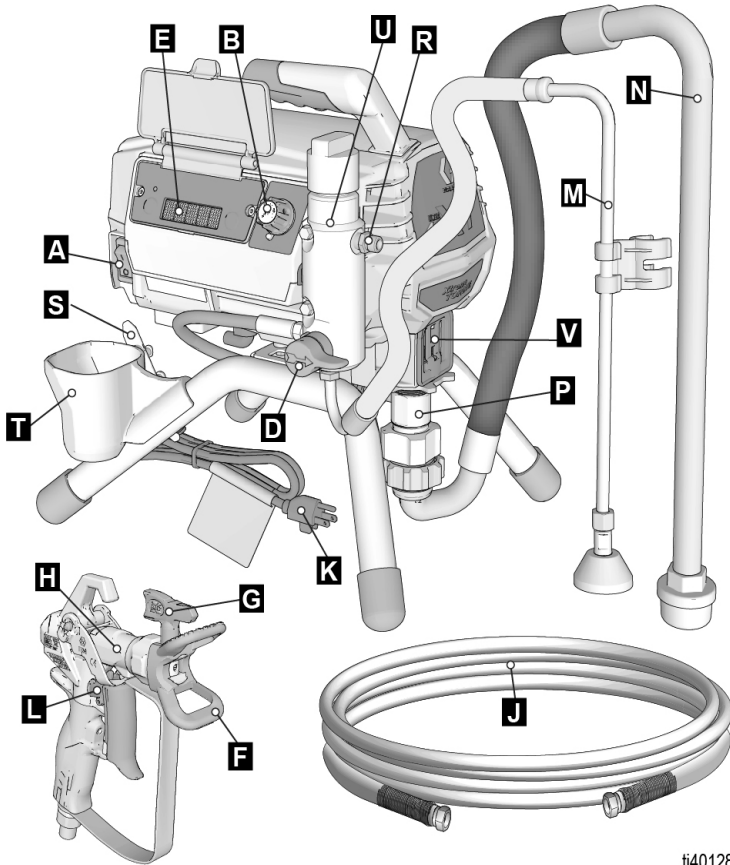

ti40128a

A	ON/OFF Switch
B	Pressure Control
D	Prime Valve
E	Controls and Display (see detailed image, pg.12)
F	Tip Guard
G	Spray Tip
H	Gun
J	Airless Hose
K	Power Cord

L	Trigger Lock
M	Drain Tube
N	Suction Tube
P	Pump
R	Fluid Outlet
S	Power Cord Wrap
T	Drip Cup
U	Filter
V	Finger Guard / TSL Fill Point
	Model/Serial Tag (Not shown, located on bottom of unit.)

Component Identification

Lo-Boy Models

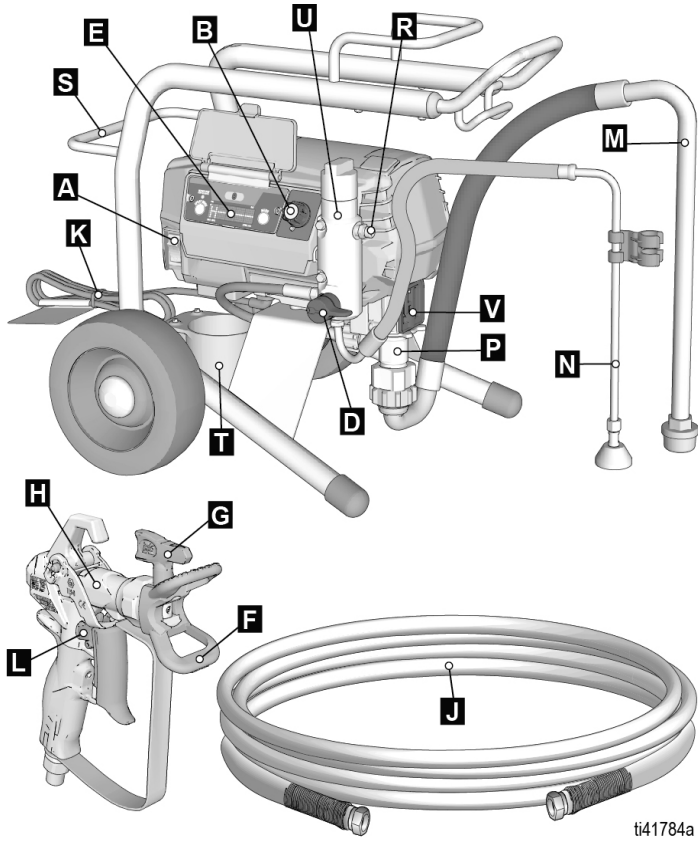

ti41784a

A	ON/OFF Switch
B	Pressure Control
D	Prime Valve
E	Controls and Display (see detailed image, pg.12)
F	Tip Guard
G	Spray Tip
H	Gun
J	Airless Hose
K	Power Cord

L	Trigger Lock
M	Drain Tube
N	Suction Tube
P	Pump
R	Fluid Outlet
S	Cord/Hose Wrap
T	Drip Cup
U	Filter
V	Finger Guard / TSL Fill Point
	Model/Serial Tag (Not shown, located on bottom of unit.)

Component Identification

Hi-Boy Models

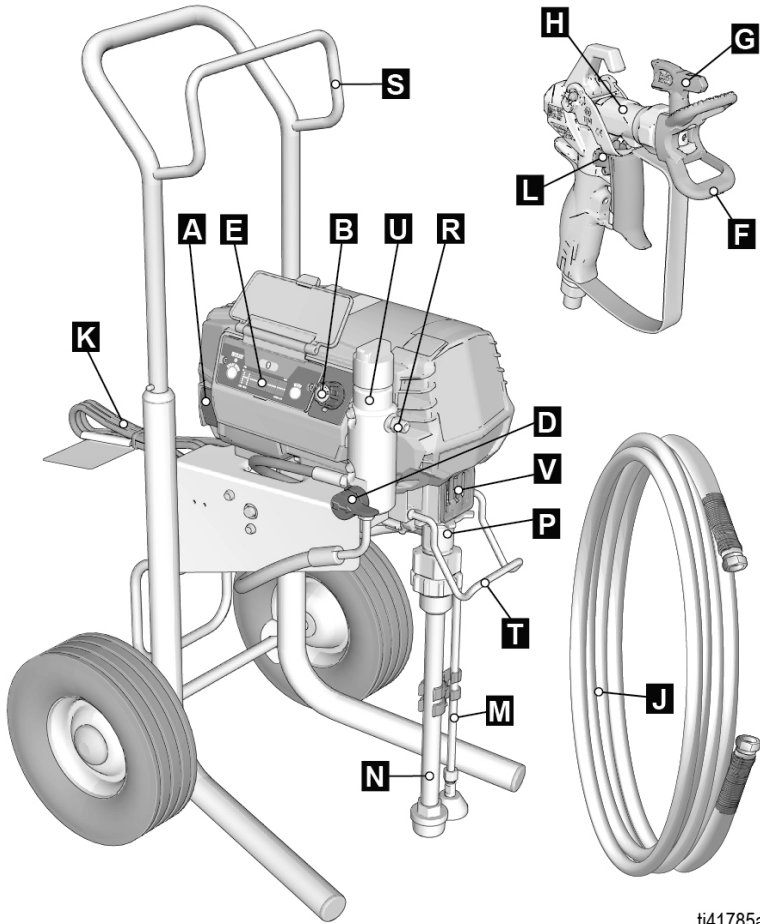

ti41785a

A	ON/OFF Switch
B	Pressure Control
D	Prime Valve
E	Controls and Display (see detailed image, pg.12)
F	Tip Guard
G	Spray Tip
H	Gun
J	Airless Hose
K	Power Cord

L	Trigger Lock
M	Drain Tube
N	Suction Tube
P	Pump
R	Fluid Outlet
S	Cord/Hose Wrap
T	Pail Hook
U	Filter
V	Finger Guard / TSL Fill Point
	Model/Serial Tag (Not shown, located on bottom of unit.)



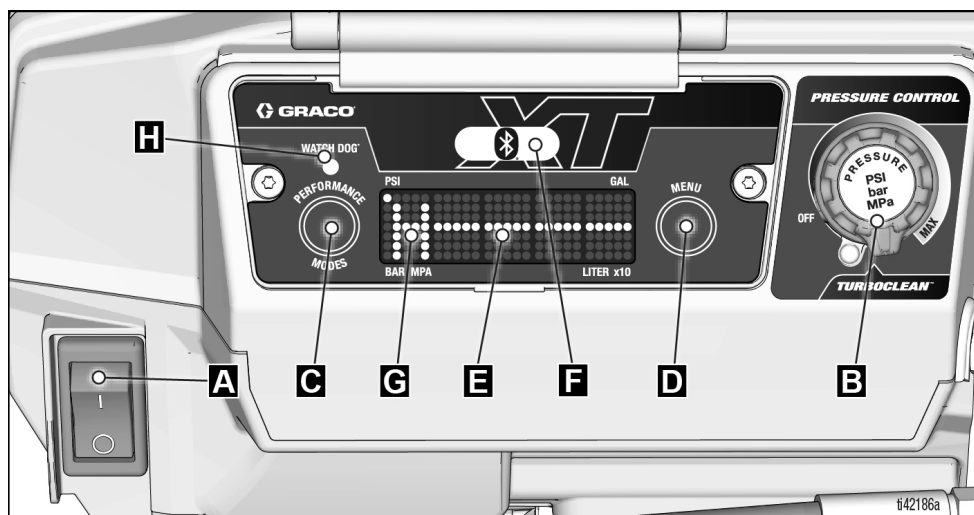

Component Identification

Controls and Display



A	ON/OFF Switch
B	Pressure Control
C	Performance Mode Button
D	Menu Button
E	LED Display
F	Bluetooth Indicator Light (if applicable)
G	Performance Mode Indicator
H	Watch Dog Indicator Light

Grounding

				
<p>The equipment must be grounded to reduce the risk of static sparking and electric shock. An electric or static spark can cause fumes to ignite or explode. An improper ground can cause electric shock. Grounding provides an escape wire for the electric current.</p>				

This sprayer is equipped with a power cord that has a ground wire and an appropriate grounding plug.

The plug must be plugged into an outlet that is properly installed and grounded in accordance with all local codes and ordinances.

Do not modify the plug provided; if it does not fit the outlet, have the proper outlet installed by a qualified electrician.

Extension Cords

Use an extension cord with an undamaged ground contact. If an extension cord is necessary, use a 3-wire, 12 AWG (2.5 mm²) minimum.

NOTE: Smaller gauge or longer extension cords may reduce sprayer performance.

Pails

Solvent and oil-based fluids: follow local code. Use only conductive metal pails, placed on a grounded surface such as concrete.

Do not place pail on a non-conductive surface such as paper or cardboard which interrupts grounding continuity.

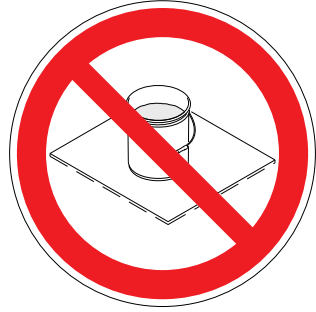

Always ground a metal pail: connect a ground wire to the pail. Clamp one end to the pail and the other end to a true earth ground such as a metal water pipe.

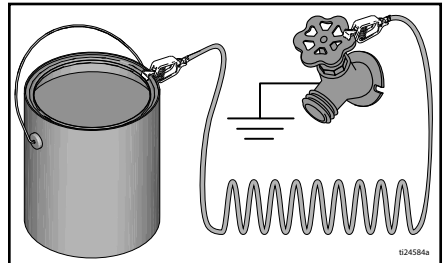

To maintain ground continuity when sprayer is flushed or pressure is relieved: hold a metal part of spray gun firmly to the side of a grounded metal pail then trigger the gun.

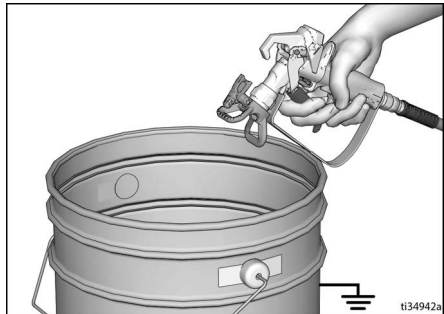

Pressure Relief Procedure

Pressure Relief Procedure



Follow the Pressure Relief Procedure whenever you see this symbol.

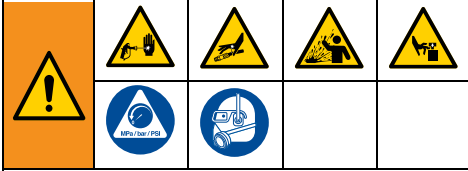

This equipment stays pressurized until pressure is manually relieved. To help prevent serious injury from pressurized fluid, such as skin injection, splashed fluid and moving parts, follow the **Pressure Relief Procedure** whenever you stop spraying and before cleaning, checking, or servicing the equipment.

1. Engage the trigger lock (L).

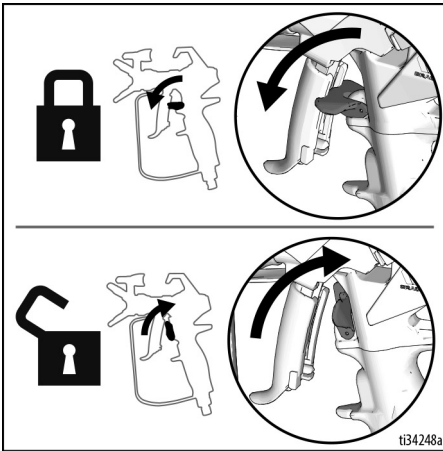

2. Turn ON/OFF switch (A) to the **OFF** position.

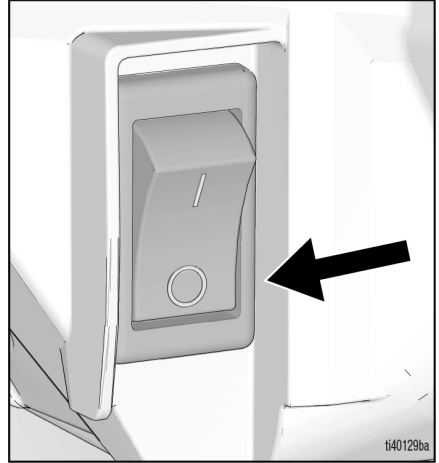

3. Turn pressure control (B) to the **OFF** position.

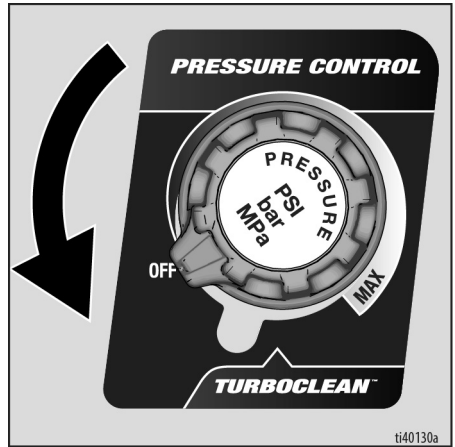

Pressure Relief Procedure

- Put drain tube (M) in a pail and turn prime valve (D) down to relieve pressure. Leave prime valve in the down (drain) position until you are ready to spray again.

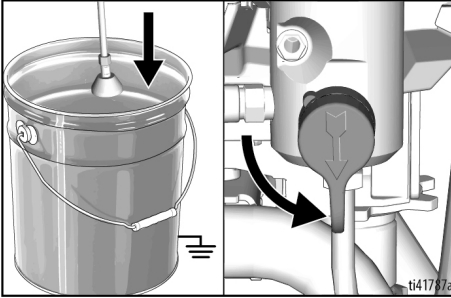

- Hold a metal part of the spray gun firmly to a grounded metal pail. Point spray gun into pail. Disengage the trigger lock and trigger the spray gun to relieve pressure.

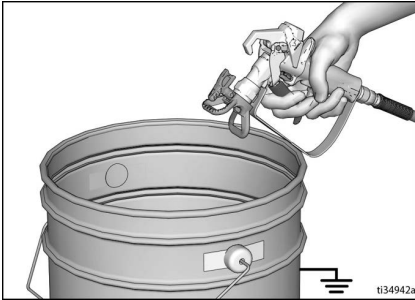

- Engage the Trigger Lock.
- If you suspect the spray tip or hose is clogged or that pressure has not been fully relieved:
 - Using a wrench, **VERY SLOWLY** loosen the tip guard retaining nut or the hose end coupling to relieve pressure gradually.
 - Using a wrench, loosen the nut or coupling completely.
 - Clear hose or tip obstruction.

Trigger Lock

Always engage the trigger lock when sprayer is stopped to prevent the gun from being triggered accidentally by hand or if dropped or bumped.



Setup

Setup

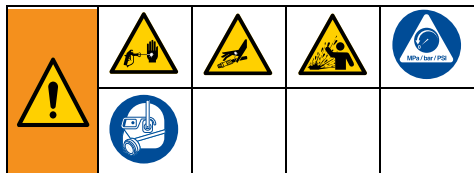

When unpacking sprayer for the first time or after long term storage perform setup procedure. When first setup is performed remove shipping plug from fluid outlet.

Sprayer is equipped with Pump Armor™ in the system.

1. Connect Graco airless hose to fluid outlet. Use wrenches to tighten securely.

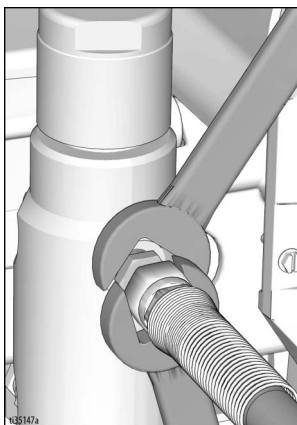

2. Connect other end of hose to gun.

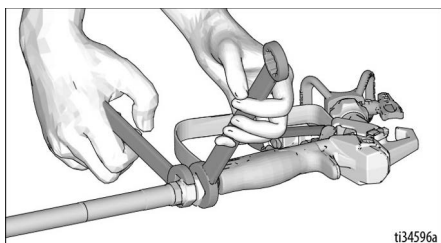

3. Use wrenches to tighten securely.

4. Engage trigger lock.

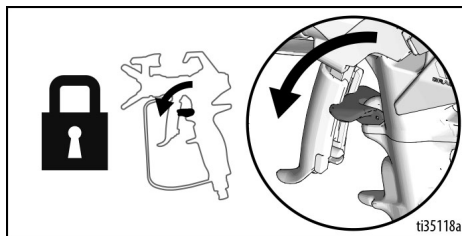

5. Remove tip guard.

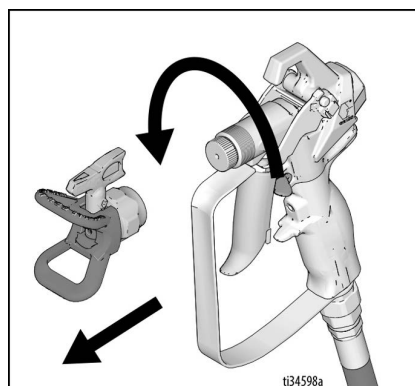

6. When unpacking sprayer for the first time remove packaging materials from inlet strainer. After long term storage check inlet strainer for clogs and debris.

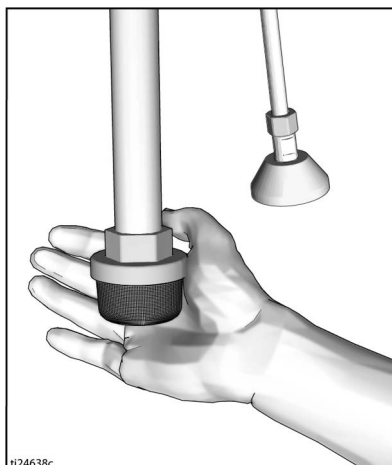

7. Fill TSL fill port (V) with TSL to prevent premature packing wear. Do this daily or each time you spray.

- a. Place the TSL bottle nozzle into the top center opening in the grill at the front of the sprayer.
- b. Squeeze bottle to dispense enough TSL to fill the space between the pump rod and packing nut seal.

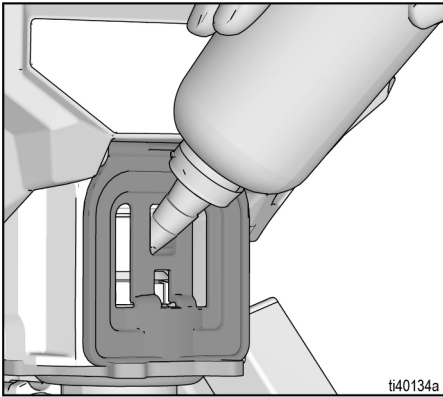

8. Make certain ON/OFF switch is **OFF** and the pressure control (B) is in the **OFF** position.

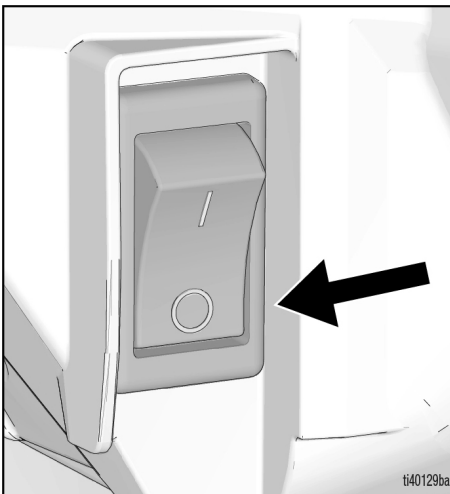

9. Plug power supply cord into a properly grounded electrical outlet.

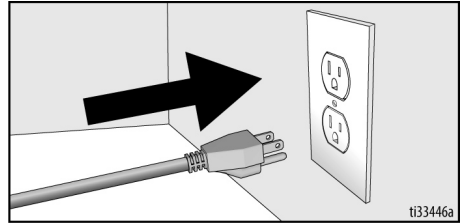

10. Turn prime valve to the down position.

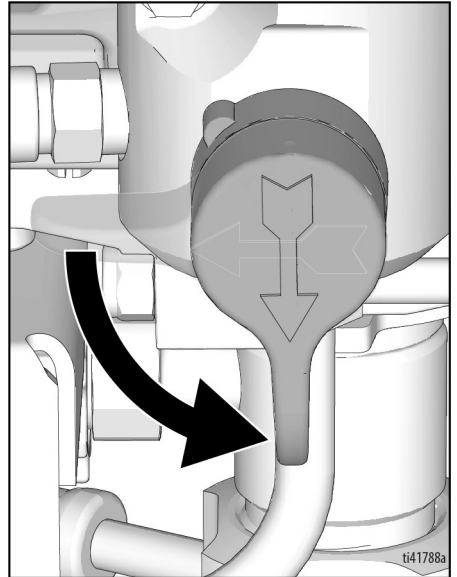

Setup

11. Place suction tube with drain tube in grounded metal pail partially filled with flushing fluid. See **Grounding**, page 13.

NOTE: Check flushing fluid for compatibility with material that is to be sprayed. A secondary flush with a compatible fluid may be necessary. Water for latex paint or mineral spirits for oil-based paint.

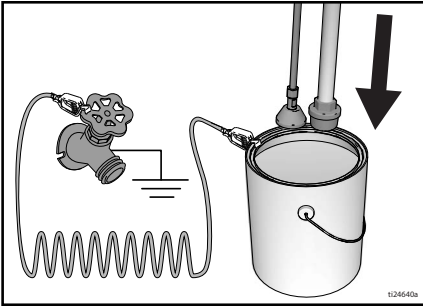

12. Turn ON/OFF switch to **ON** position.
13. Turn prime valve horizontal. Disengage trigger lock.
14. Turn pressure control up until sprayer begins to run.
15. Hold a metal part of the spray gun firmly to a grounded metal pail. Trigger gun and flush for one minute.
16. Turn ON/OFF switch to **OFF** position.
17. Engage trigger lock.
18. Sprayer is now ready for startup.

Startup

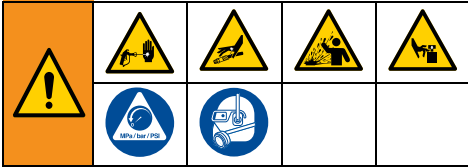

1. Perform **Pressure Relief Procedure**, page 14.
2. Remove spray tip and tip guard.
3. Turn pressure control **OFF**.

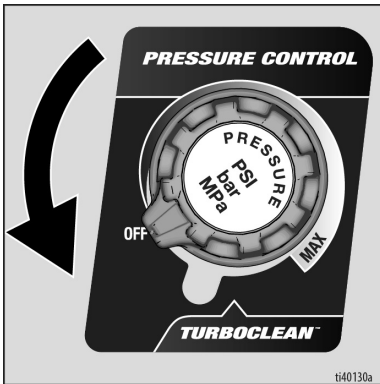

4. Turn the prime valve down.
5. Turn ON/OFF switch to **ON** position.

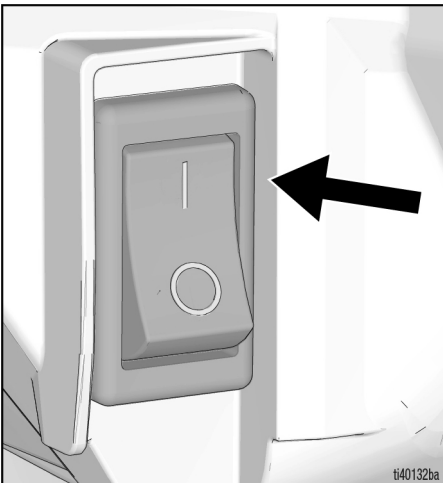

6. Place suction tube in paint pail. Place drain tube in waste pail.

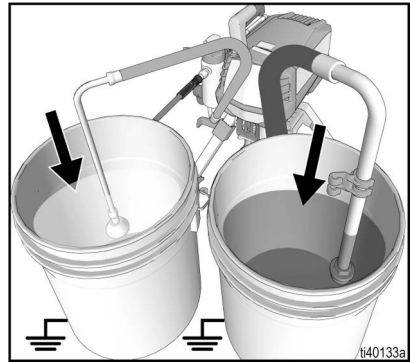

7. Turn pressure control to 10 o'clock position. Allow paint to circulate through drain tube for 15 seconds.

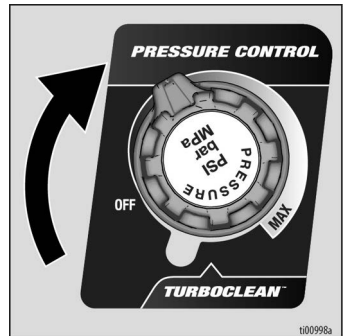

8. Turn prime valve horizontal. Disengage trigger lock.

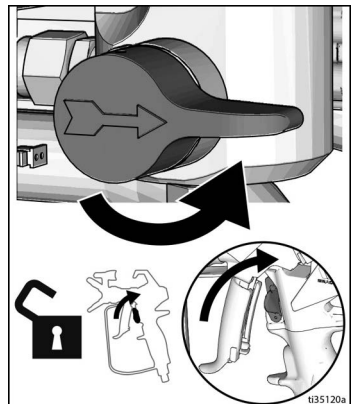

Startup

9. Hold a metal part of the spray gun against grounded metal waste pail. Trigger gun until paint appears.

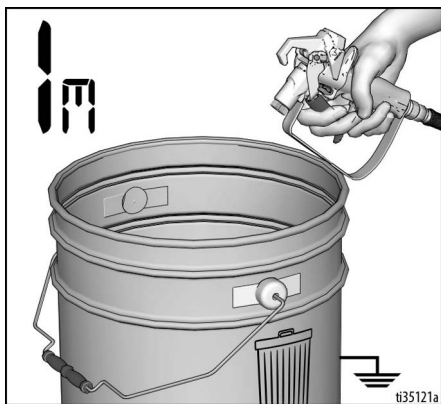

10. Move gun to paint pail and trigger for 20 seconds. Release trigger and allow sprayer to build pressure. Engage trigger lock.



High-pressure spray is able to inject toxins into the body and cause serious bodily injury. Do not stop leaks with hand or rag.				

11. Inspect airless hose connections for leaks. If leaks occur, perform **Pressure Relief Procedure**, page 14, then tighten all fittings and repeat Startup procedure. If there are no leaks continue with the next step.
12. Follow **Spray Tip Installation**, page 21. For gun assembly instructions, see separate gun manual.

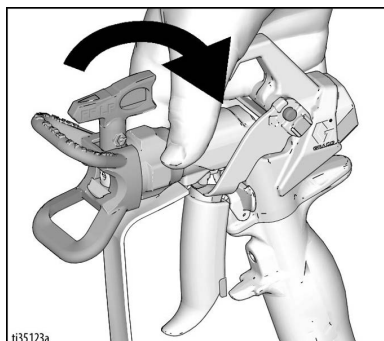

13. Select the Performance Mode best suited for your application. To learn more about Performance Modes and how to select them, see **Performance Modes**, page 21 and **Selecting Performance Modes**, page 27.

Operation

Spray Tip Installation



To avoid serious injury from skin injection do not put your hand in front of the spray tip when installing or removing the spray tip and tip guard.

1. Perform **Pressure Relief Procedure**, page 14.
2. Use spray tip (A) to insert OneSeal™ (B) into tip guard (C).

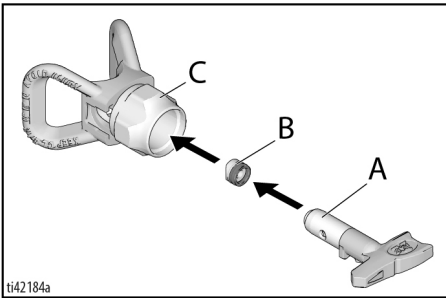

3. Insert Spray Tip.

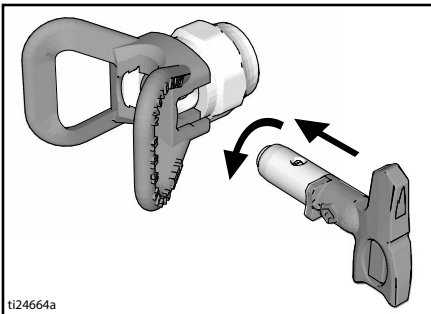

4. Screw assembly onto gun. Tighten.

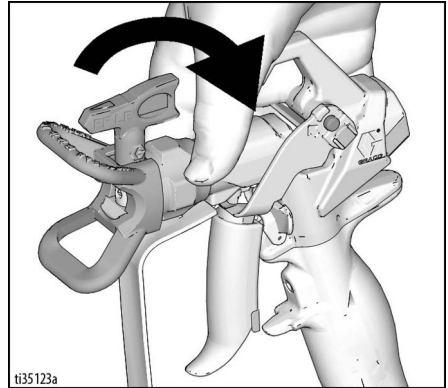

Performance Modes

The sprayer is equipped with two spray modes.

Low Pressure Mode (L): 50-2,000 psi

- Designed for RAC X Low Pressure Switch Tips (RAC X FFLP, LP and WRLP) to reduce overspray and minimize tip and sprayer life.
- Allows increase in pressure in 10 psi increments for improved control. Best suited for specific pressure requirements.
- Full control down to 50 psi.

High Pressure Mode (H): 500-3,300 psi

- Recommended for use with thick or cold materials, and when using extended hose lengths.
- Allows increase in pressure in 50 psi increments.

To select or change the spray mode, see **Selecting Performance Modes**, page 27.

Operation

Spray

When RAC X™ Low Pressure Switch Tips (FFLP, LP and WRLP) are used, spraying pressure can be lowered. Spraying at a lower pressure results in less overspray and reduces spray tip wear. Adjust the sprayer pressure to minimize overspray.

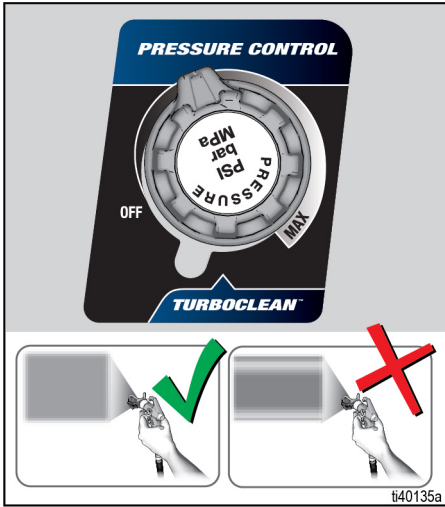

Spraying with atomized, evenly distributed fan pattern

Spraying with tails

1. Spray test pattern. Adjust pressure to eliminate heavy edges.

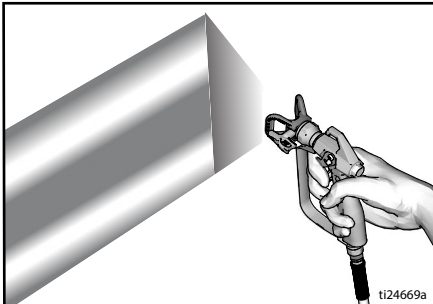

2. Use smaller tip size if pressure adjustment cannot eliminate heavy edges.

3. Hold gun perpendicular, 10-12 in. (25-30 cm) from surface. Spray back and forth; overlap by 50%.

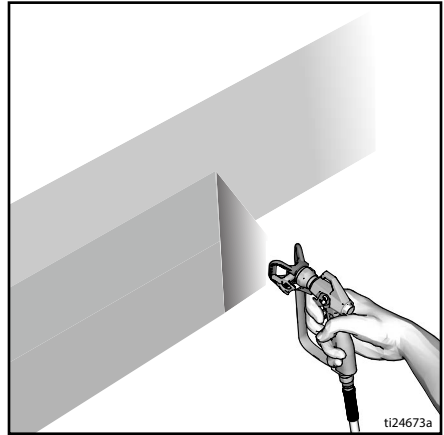

4. Trigger gun after moving. Release trigger before stopping. For additional spraying information, see separate gun manual.

Clear Spray Tip Clog

To avoid injury from skin injection, never point gun at your hand or into a rag!				

1. Release trigger. Engage trigger lock. Rotate Spray Tip. Disengage trigger lock. Trigger gun at waste area to clear clog.

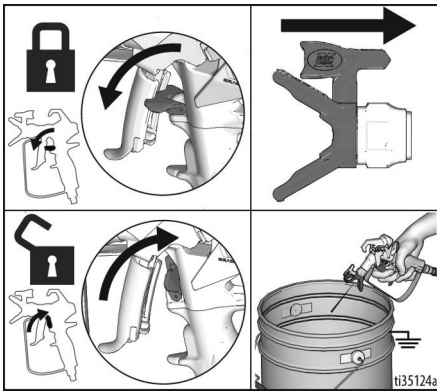

2. Engage trigger lock. Return Spray Tip to original position. Disengage trigger lock and continue spraying.

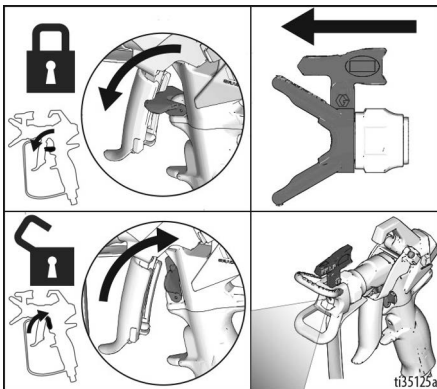

Cleanup

1. Perform **Pressure Relief Procedure**, page 14.
2. Remove tip guard and Spray Tip. For additional information, see separate gun manual.

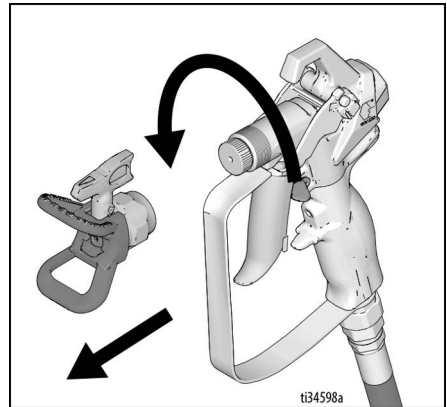

3. Remove suction tube and drain tube from paint, wipe excess paint off outside.

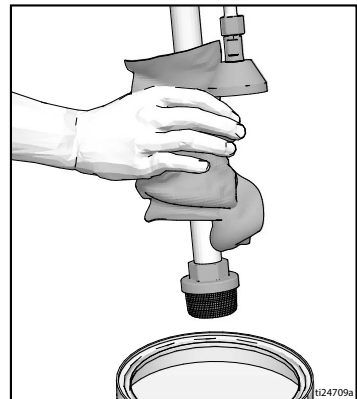

Operation

- Place suction tube in flushing fluid. Use water for water base paint and mineral spirits for oil-based paint. Place drain tube in waste pail.

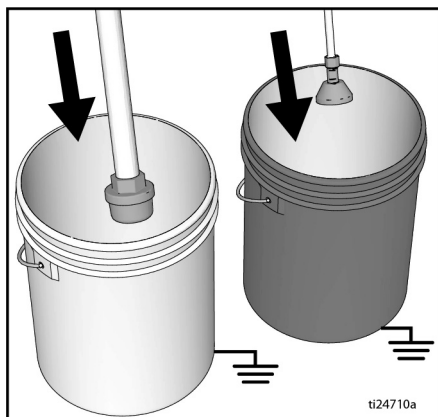

- To pump, turn prime valve to down position.

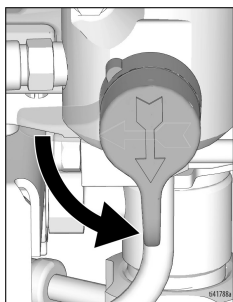

- Turn pressure control to TurboClean™.

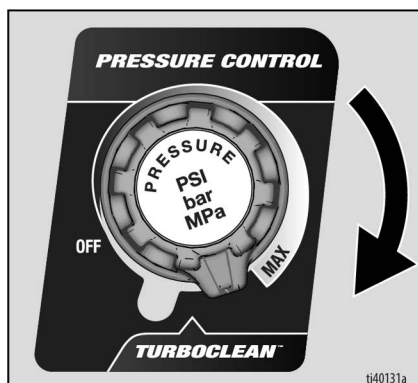

- Trigger gun until the pump runs steady and flushing fluid appears clear in the waste pail.

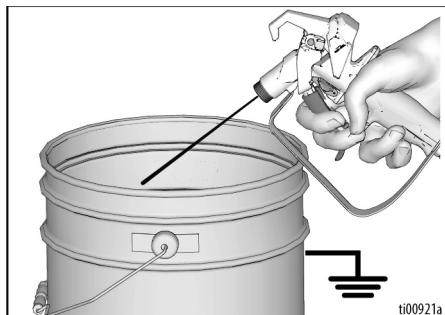

- Turn pressure control to OFF position.

Flush Hose and Gun

- To flush airless hose and spray gun, turn prime valve horizontal.
- Hold a metal part of the spray gun against waste pail. Disengage trigger lock.

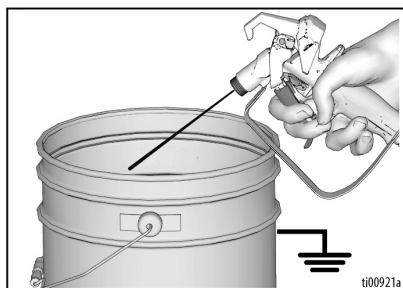

- Trigger gun and turn pressure control to TurboClean.

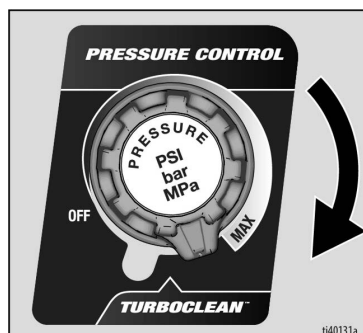

- Operate until the pump runs steady and flushing fluid appears clear.
- Turn pressure control to OFF.

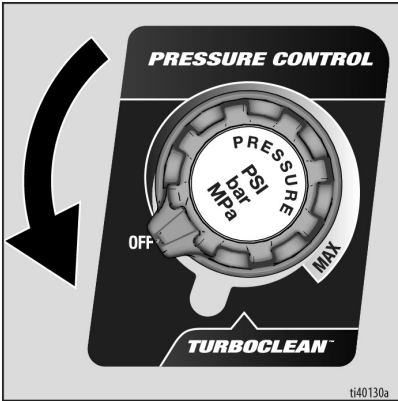

- Stop triggering gun.
- Raise suction tube above flushing fluid.

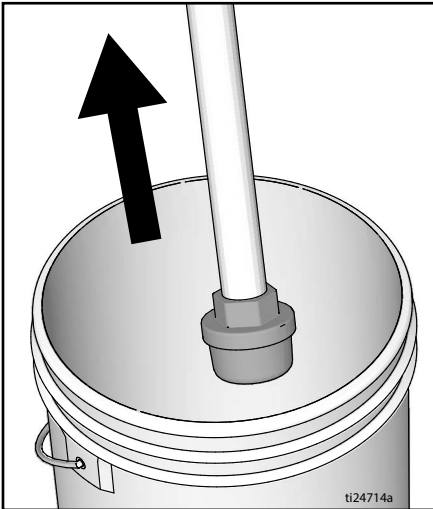

- While triggering gun into flushing pail, turn pressure control to TurboClean to purge fluid from hose.

- Engage trigger lock.



- Turn pressure control knob to OFF and turn ON/OFF switch to OFF position. Disconnect power to sprayer.

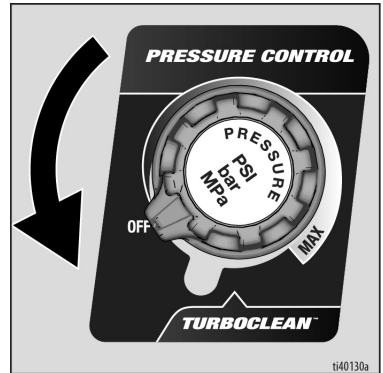

- Remove filter from gun and sprayer if installed. Clean and inspect. Install filter. See separate gun manual.
- If flushing with water, flush again with Pump Armor to leave a protective coating to prevent freezing or corrosion.
- Wipe sprayer, hose and gun with a rag soaked in water or mineral spirits.

Digital Display

Digital Display

All models are equipped with a digital display. This section explains how to use this feature.



Operation Main Menu

A short press of the menu button moves to the next display. Press and hold menu button to change units or reset data.

1. Perform **Pressure Relief Procedure**, page 14.
2. Turn ON/OFF switch to **OFF** position.
3. Plug sprayer into grounded outlet. Turn ON/OFF switch to **ON** position.

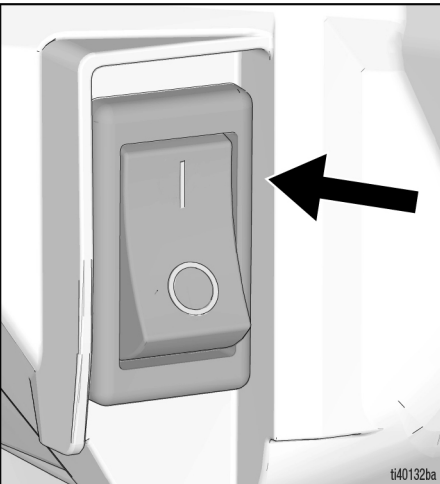
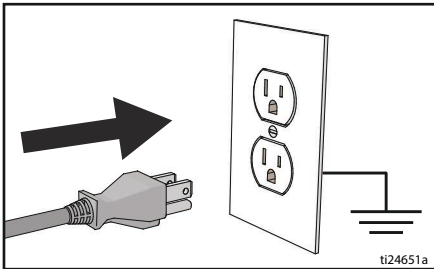

4. Pressure display appears. Dashes appear when pressure is less than 50 psi (3 bar, 0.3 MPa).

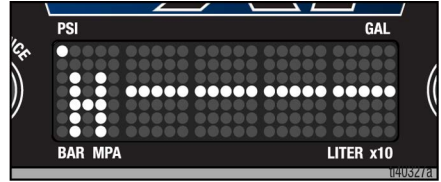

5. Short press menu button to move to Job Gallons (or Liters x 10).

NOTE: JOB displays briefly, then the number of gallons sprayed.



6. Press and hold menu button to reset to zero, or short press button to move to Lifetime Gallons (or Liters x10).

NOTE: LIFE displays briefly, then the number of gallons sprayed above 600 psi (41 bar, 4.1MPa).

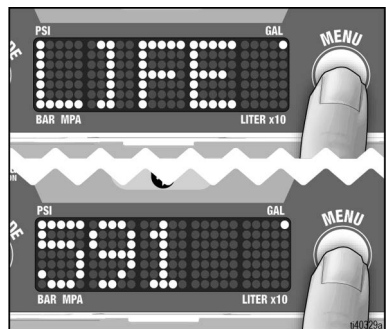

7. To change pressure units (psi, bar, or MPa), press and hold menu button until the desired units appear (approximately 10 seconds). Selection of bar or MPa changes gallons to Liters x10.

NOTE: This **ONLY** works when pressure is displayed. Pressure units are displayed on the left side of display.

Selecting Performance Modes

Unit is equipped with two performance modes. Performance modes are selected by pressing the “Performance Mode” button on the left side of the display. The mode will scroll across the display either “High Pressure” or “Low Pressure”. They are denoted by a one letter symbol on the left side of the display.

For an explanation of performance modes, see **Performance Modes**, page 21.

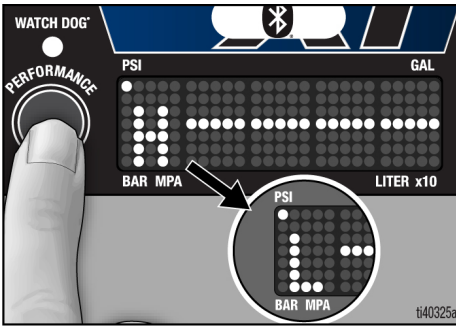

Watchdog

The Watchdog™ Pump Protection System automatically shuts down the pump when material runs out or prime is lost.

To enable Watchdog, press and hold “Performance Mode” button until Watchdog LED is illuminated. Press and hold “Performance Mode” button to disable Watchdog.

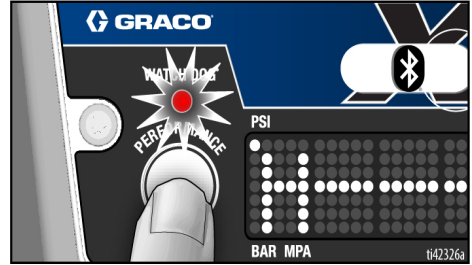

If the material in the spray bucket drops below the suction tube the sprayer will lose prime and will no longer stall when the gun is de-triggered. Watchdog detects this and will stop the sprayer from running and putting unnecessary wear on the pump. The display will read “EMPTY” while Watchdog has the sprayer stopped.

TurboClean

Unit is equipped with TurboClean cleaning mode. To enable, turn pressure control knob to TurboClean setting. When entering TurboClean, there will be a notable detent in the pressure and CLEAN will flash on the display.



NOTE: TurboClean is only used for cleaning fluids. When in TurboClean, the sprayer will not spray paint or other materials.

To restart the sprayer press the menu button and the prime the sprayer to resume spraying.

NOTE: Watchdog does not operated at less than 1,000 psi (69 bar).

NOTE: It is recommended to deactivate Watchdog during cleaning of the sprayer.

There are three Watchdog sensitivity levels that can be set in the Stored Data Display; see, **Stored Data Display**, page 28.

Low: This is the least sensitive setting and requires the most material to be sprayed before Watchdog activates.

Medium: A mid-level sensitive setting between high and low.

High: This is the most sensitive setting. Watchdog will activate quickly. False triggering could occur in this mode. If this occurs, select a lower sensitivity.

Digital Display

Stored Data Display

1. Perform **Pressure Relief Procedure**, page 14.
2. Press and hold menu button while turning ON/OFF switch to **ON** position.

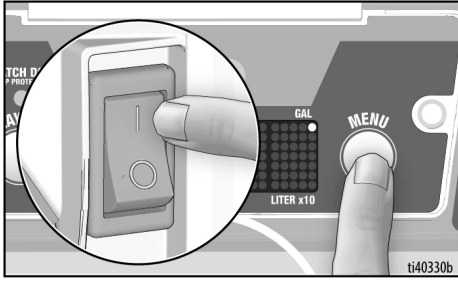

3. Serial code will scroll across display.

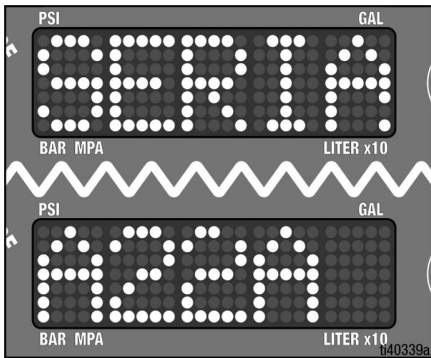

4. Short press menu button and the total motor run hours is displayed.
5. Short press menu button and the last error code is displayed: e.g., **E=03**. Press and hold menu button to clear error code to zero.

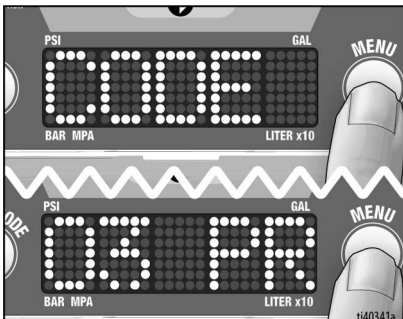

6. Short press to move to Watchdog.

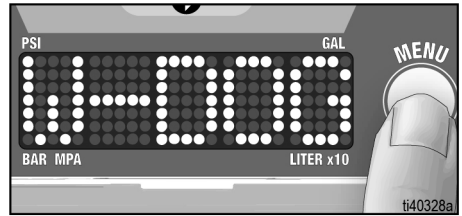

7. Press and hold menu button to change Watchdog sensitivity setting (High, Medium, Low). Default is set to Low.

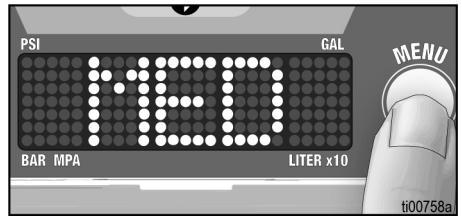

8. Short press menu button to move software Rev.
9. Short press menu button to move to Sprayer ID.
10. Short press menu button to move to **Knob Calibration**, page 29 and **Transducer Calibration**, page 29.
11. Turn ON/OFF switch to **OFF** position to exit Stored Data.

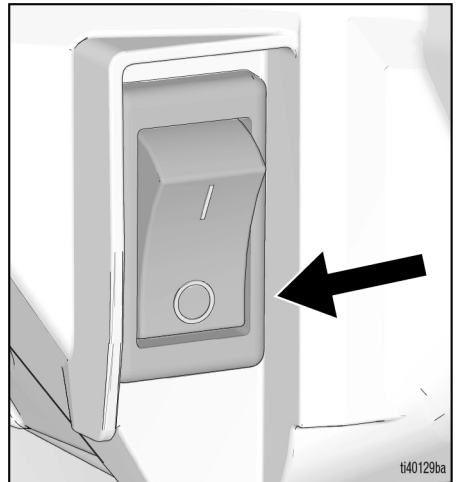

Knob Calibration

NOTE: Knob calibration should be performed whenever a new pressure control (potentiometer) is installed or the control board is replaced.

1. To perform knob calibration, enter secondary menu by holding menu button while powering sprayer.
2. Use menu button to navigate to knob calibration screen.

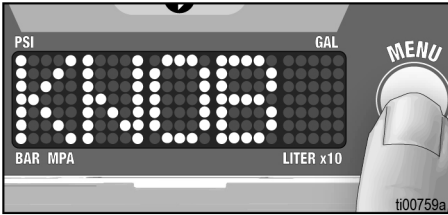

3. Set potentiometer to max spray position, just before TurboClean.

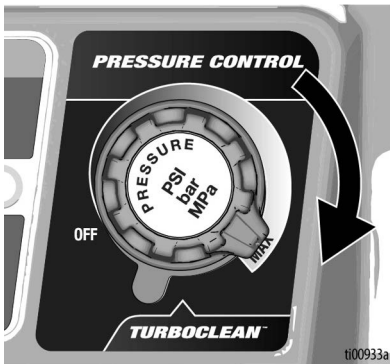

4. Hold menu button until display shows pass.



5. Turn potentiometer knob back to **OFF** position before restarting and reusing the sprayer.

Transducer Calibration

NOTE: Transducer calibration should be performed whenever a new transducer is installed or the control board is replaced.

1. Perform **Pressure Relief Procedure**, page 14.
2. To perform transducer calibration, enter secondary menu by holding menu button while powering sprayer.
3. Use menu button to navigate to 0 (zero) calibration screen.



4. Make sure dump valve is open and that there is no pressure in sprayer.
5. Press and hold menu button until display shows pass.

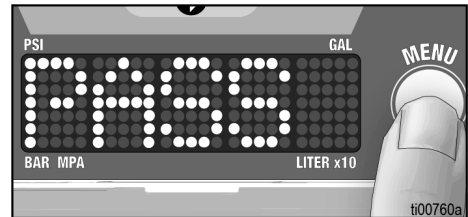

BlueLink[®] App

(If applicable. Units equipped with BlueLink have a BlueLink indicator light on the display, see **Controls and Display**, page 12.)

Download the Graco BlueLink app from the Apple App Store, Google Play, or other available application stores to connect to the paint sprayer via Bluetooth[®].

The BlueLink app allows you to access sprayer information, settings, statistics, and provides access to useful features such as Watchdog[™], improved maintenance tracking, sprayer tracking, and job tracking. Find the Graco BlueLink App at:

<https://www.graco.com/BlueLink>



Further instructions can be accessed within the app. Instructions can also be accessed online at:

<https://www.graco.com/BlueLinkSupport>



Maintenance

Routine maintenance is important to ensure proper operation of your sprayer. Maintenance includes performing routine actions which keep your sprayer in operation and prevents trouble in the future.



1. Perform **Pressure Relief Procedure**, page 14, before performing maintenance.

Activity	Interval
Inspect/clean sprayer filter, fluid inlet strainer, and gun filter.	Daily or each time you spray
Inspect motor shield vents for blockage.	Daily or each time you spray
Fill TSL by adding through TSL fill point.	Daily or each time you spray
Check sprayer stall. With sprayer gun NOT triggered, sprayer motor should stall and not restart until gun is triggered again. If sprayer starts again with gun NOT triggered, inspect pump for internal/external leaks and check prime valve for leaks.	Every 100 gallons (400 liters)
Throat packing adjustment When pump packing begins to leak after extended use, tighten packing nut down until leakage stops or lessens. This allows approximately 100 gallons of additional operation before a repacking is required. Packing nut can be tightened without o-ring removal.	As necessary based on usage



Maintenance can be scheduled and tracked via the Graco BlueLink app.

Recycling and Disposal at End of Life

At the end of the product's useful life, dismantle and recycle it in a responsible manner.

Preparation:

- Perform the **Pressure Relief Procedure**, page 14.
- Drain and dispose of fluids according to applicable regulations. Refer to the material manufacturer's Safety Data Sheet.

Dismantle and recycle:

- Remove motors, circuit boards, displays, and other electronic components. Remove the coin-cell battery from the battery holder on the control board. Recycle according to applicable regulations.
- Do not dispose of electronic components with household or commercial waste.
- Deliver remaining product to a recycling facility.

Troubleshooting

Mechanical/Fluid Flow

1. Follow **Pressure Relief Procedure**, page 14, before checking or repairing.
2. Check all possible problems and causes before disassembling the unit.

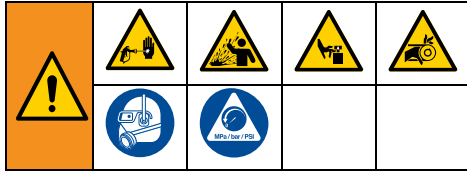

To help prevent serious injury from pressurized fluid, such as skin injection, splashing fluid, and moving parts, follow the **Pressure Relief Procedure** when you stop spraying and before cleaning, checking, or servicing the equipment.

Keep clear of moving parts during troubleshooting procedures.

Problem	What to Check If check is OK, go to next check	What to Do When check is not OK, refer to this column
Control board status light is blinking or the light is off and there is power to the sprayer	Fault condition exists.	Determine fault correction from Electrical , page 34.
Pump output is low	Spray tip worn.	Replace tip. See separate gun or tip manual.
	Spray tip clogged.	Clear tip. See Clear Spray Tip Clog , page 23.
	Paint supply.	Refill and reprime pump.
	Intake strainer clogged.	Remove and clean, then reinstall. If problem persists, strain the paint.
	Intake valve ball and piston ball are not seating properly.	Remove intake valve and clean. Check balls and seats for nicks; replace if necessary. See pump manual. Strain paint before using to remove particles that could clog pump.
	Fluid filter or tip filter is clogged or dirty.	Remove and clean, then reinstall.
	Prime valve leaking.	Repair prime valve.
	Verify pump does not continue to stroke when gun trigger is released. (Prime valve not leaking.)	Service pump. See pump manual.
Leaking around throat packing nut which may indicate worn or damaged packings.	Tighten packing nut/wet-cup. Replace packings. See pump manual. Also check piston valve seat for hardened paint or nicks and replace if necessary.	

Problem	What to Check If check is OK, go to next check	What to Do When check is not OK, refer to this column
Pump output is low	Low stall pressure.	Change spray mode to High Pressure. Turn pressure knob fully clockwise. Make sure pressure control knob is properly installed to allow full clockwise position. Perform Knob Calibration , page 29. If problem persists, replace pressure transducer.
	Pump rod damage.	Repair pump. See pump manual.
	Piston packings are worn or damaged.	Replace packings. See pump manual.
	O-ring in pump is worn or damaged.	Replace o-ring. See pump manual.
	Intake valve ball is packed with material.	Clean intake valve. See pump manual.
	Large pressure drop in hose with heavy materials.	Reduce overall length of hose.
	Check extension cord for correct size.	See Extension Cords , page 13.
	Connecting rod assembly damaged.	Replace connecting rod assembly.
Motor doesn't run	Error code on the display.	Determine fault correction from electrical, see page 34.
	Motor cables damaged or loose connections.	Reconnect or replace if necessary.
	Potentiometer wire damaged or loose connections.	Reconnect or replace if necessary.
	Control board, see page 35.	Replace power cord or control board.
	Additional motor troubleshooting.	See page 36.
Motor runs but pump does not stroke	Connecting rod assembly damaged.	Replace connecting rod assembly.
Excessive paint leakage into throat packing nut	Throat packing nut is loose.	Remove throat packing nut spacer. Tighten throat packing nut just enough to stop leakage.
	Throat packings are worn or damaged.	Replace packings.
	Displacement rod is worn or damaged.	Replace rod.
Fluid is spitting from gun	Air in pump or hose.	Cycle pump as slowly as possible during priming. Purge paint through gun by following Startup instructions 5-8, pg. 19.
	Spray tip is partially clogged.	Clear tip. See Clear Spray Tip Clog , page 23.
	Fluid supply is low or empty.	Refill fluid supply. Prime pump. Check fluid supply often to prevent running pump dry.
Pump is difficult to prime	Clog in prime valve.	Remove prime valve, check for clogs, replace.
	Air in pump or hose.	Check and tighten all fluid connections. Cycle pump as slowly as possible during priming.
	Intake valve is leaking.	Clean intake valve. Be sure ball seat is not nicked or worn and that ball seats well. Reassemble valve.
	Pump packings are worn.	Replace pump packings. See pump manual.
	Paint is too thick.	Thin the paint according to supplier recommendations.
Pump loses prime	Leak in suction tube.	Replace suction tube.
	Debris stuck in inlet ball.	Remove foot valve and clean with appropriate cleaning solution.

Troubleshooting

Electrical



To avoid injury from electrical shock when covers are removed, wait five minutes after disconnecting power cord for stored electricity to dissipate.

Symptom: Sprayer does not run, stops running, or will not shut off.

1. Perform **Pressure Relief Procedure**, page 14.

2. Unplug sprayer and turn the ON/OFF switch to **OFF**.
3. Wait 30 seconds, then plug power supply cord into a properly grounded electrical outlet. Switch back **ON** again (this ensures sprayer is in normal run mode).
4. Turn pressure control knob clockwise 1/2 turn.
5. Error code will be shown on display.



To avoid serious injury from electrical shock and moving parts, do not remove interior motor cover or touch electrical components.

Error Code Messages

CODE	MESSAGE	ACTION
02	Code 02-High pressure detected	Relieve pressure. Check for clogs in filters and hoses. Use minimum of 50 ft. (15 m) of Graco hose. Check transducer.
03	Code 03-Pressure transducer not detected	Turn sprayer OFF and unplug the sprayer. Remove shroud. Check transducer cable and connection to control board. Check transducer.
04	Code 04-Multiple incoming voltage surges detected	Turn sprayer OFF and unplug the sprayer. Locate good voltage supply to prevent damage to electronics.
05	Code 05-Motor not spinning due to high mechanical load	Turn sprayer OFF and unplug the sprayer. Attempt to spin motor, see page 36. Motor should spin freely. If motor doesn't spin easily, remove pump and re-check by spinning motor again. If motor spins easily, check control board.
06	Code 06-Motor thermal protection enabled	Keep sprayer plugged in and allow time to cool. This may take up to an hour. Check vents in bottom and top of sprayer for blockage. If applicable, check fan connector and wiring, fan should be running. Unplug sprayer and check to make sure the motor spins freely, see page 36.
08	Code 08-Incoming voltage too low for sprayer operation	Turn sprayer OFF and unplug the sprayer. Locate good voltage supply to prevent damage to electronics.
09	Code 09-Communication to encoder failed	Turn sprayer OFF and unplug the sprayer and wait five minutes. Remove shroud. Check cables and connections. Check motor, see page 36.
10	Code 10-Control board thermal protection enabled	Keep sprayer plugged in and allow time to cool. This may take up to an hour. Check vents in bottom and top of sprayer for blockage. If applicable, check fan connector and wiring, fan should be running. Unplug sprayer and check to make sure the motor spins freely.
12	Code 12-Excessive current protection enabled	Cycle power ON and OFF . If problem persists, check motor, see page 36.
15	Code 15-Motor not spinning, no motor current detected	Turn sprayer OFF and unplug the sprayer and wait five minutes. Remove shroud. Check cables and connections. Check control board. Check motor, see page 36.
17	Code 17-Control board plugged into wrong voltage	Turn sprayer OFF and unplug the sprayer, Locate good voltage supply to prevent damage to electronics, see page 36.

Control Board



To avoid injury from electrical shock and moving parts, do not remove interior motor cover or touch electrical components.

Symptom: Sprayer does not run or stop running.

1. Check voltage supply to the board.
 - a. With multimeter, measure the AC voltage from the end of the power cord (L1in and L2in). AC voltage should read 100-127 VAC or 220-240 VAC, depending on location.
 - b. If voltage is low or not present, check power supply from wall. If power supply from wall is good, unplug from wall and allow five minutes for voltage to drain from board.
 - c. Check wiring, power cord, or connectors for damage.
2. Check for physical damage.

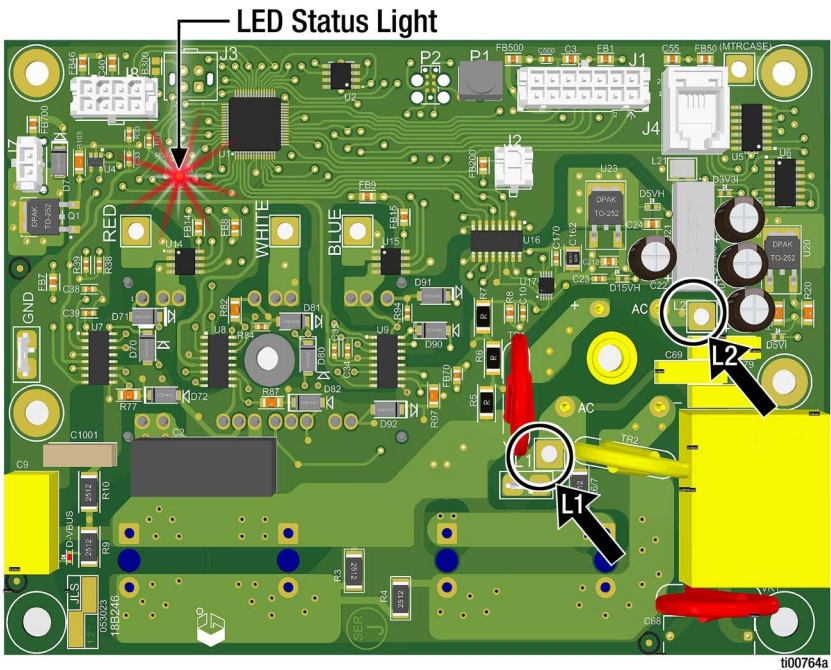

ti00764a

Troubleshooting

Motor



To avoid injury from electrical shock when covers are removed, wait five minutes after disconnecting power cord for stored electricity to dissipate.

Symptom: Unit doesn't run, runs rough, or is noisy.

1. Turn sprayer **OFF** and unplug the power cord.
2. Remove the top sprayer shroud.
3. Remove pump.
4. Remove the control board.
5. Motor should spin freely with no binding or excessive cogging. If motor binds or requires excessive force to spin, replace motor.
6. With multimeter, measure the resistance between the following phases:
 - a. A to B
 - b. B to C
 - c. A to C
7. Resistance values should be equal. If resistance values are significantly different from one another ($>0.5 \Omega$), replace motor.
8. Install pump.
9. Install control board.
10. Install top sprayer shroud.

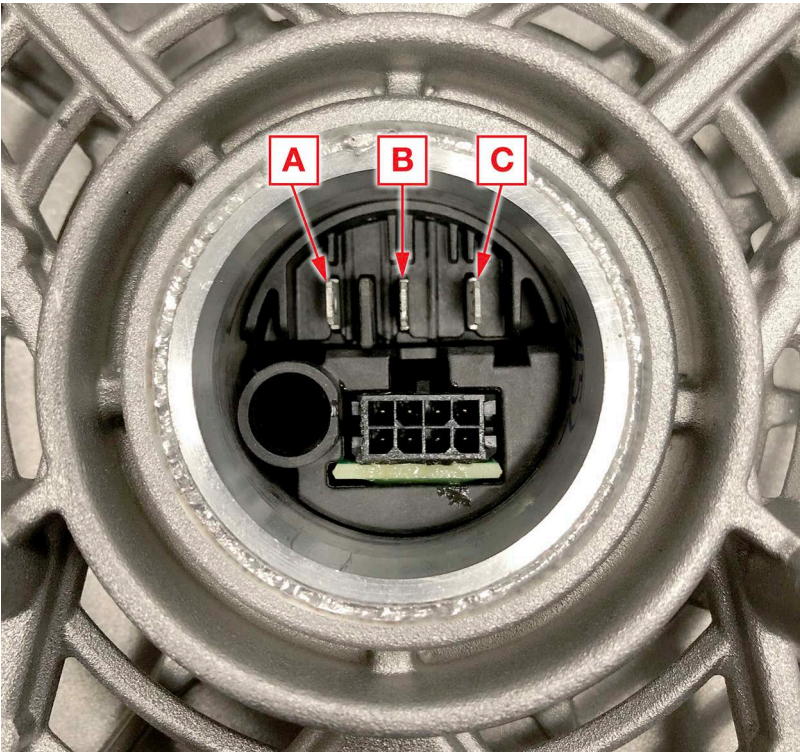

Parts

Stand Models 490 XT, 495 XT

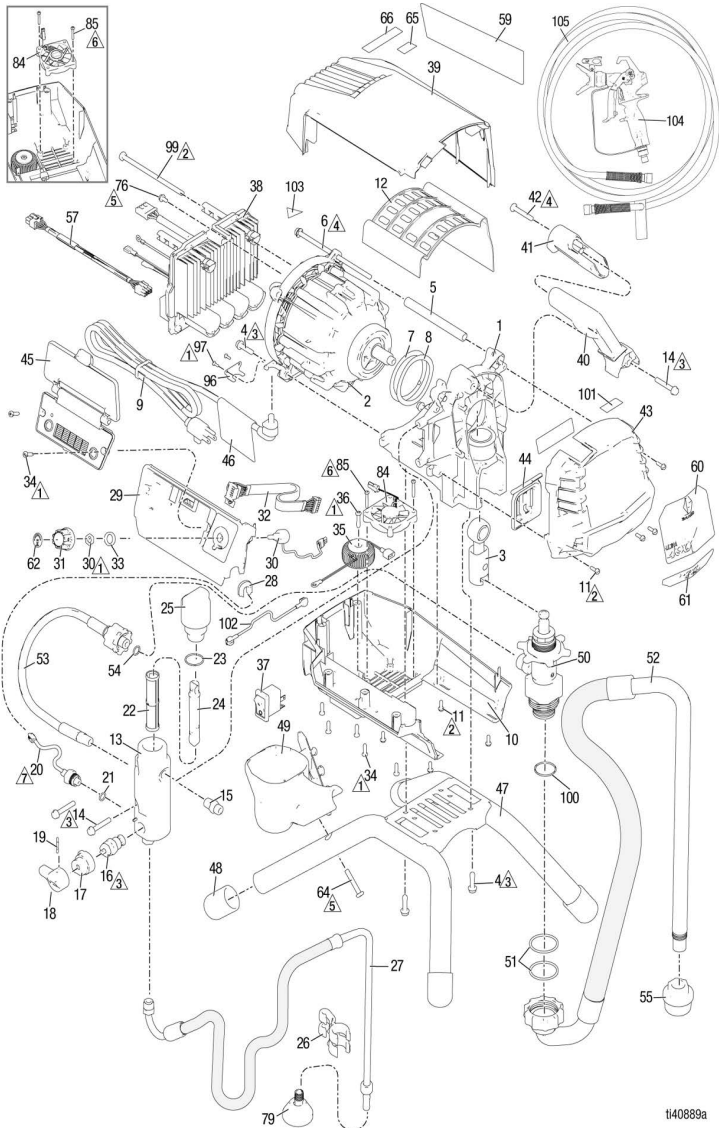

t140889a

Ref.	Torque	Ref.	Torque	Ref.	Torque
	12-16 in-lb (1.4-1.8 N•m)		70-75 in-lb (7.9-8.5 N•m)		37-43 ft-lb (50.2-58.3 N•m)
	20-25 in-lb (2.3-2.8 N•m)		40-45 in-lb (4.5-5.1 N•m)		
	140-160 in-lb (15.8-18.1 N•m)		8-10 in-lb (0.9-1.1 N•m)		

Stand Model Parts List 490 XT, 495 XT

Ref.	Part	Description	Qty.	Ref.	Part	Description	Qty.
1	20B413	HOUSING, pump with sleeve, <i>includes 4, 7, 8</i>	1	39	2002367 20B443	110V UK SHIELD, motor, top, painted, <i>includes 34</i>	1
2		MOTOR, Graco, XT, <i>includes 4, 5, 6, 7, 8</i>	1	40	20B429	HANDLE, sprayer, <i>includes 14, 41, 42</i>	1
	19C924	490		41	19C891	GRIP, handle	1
	19D860	495		42	19D260	SCREW, mach, pan hd., torx	1
3	20B414	ROD, connecting, SM electrical assembly	1	43	20B430	COVER, front, painted, <i>includes 11</i>	1
4	20B534	SCREW, mach, hex washer hd.	6	44	17C484	COVER, PC Pro pump rod	1
5	20B415	SPACER, tie rod, motor, <i>includes 6</i>	2	45	20B431	MODULE, display only, <i>includes 34</i>	1
6	19C928	SCREW, cap, 1/4-20 x 6	2		20B432	MODULE, Bluelink with display, <i>includes 34</i>	1
7	19C534	SPRING, wave washer	1	46 ▲	See pg. 48	LABEL, warning, English, French, Spanish	1
8	19C535	SHIM	1	47	20B433	FRAME, standmount, <i>includes 4, 48</i>	1
9	See pg. 48	CORD, power, lighted, <i>includes 46</i>	1	48	19D306	CAP, leg	4
10	20B421	SHIELD, motor, bottom, <i>includes 11, 36, 37, 85</i>	1	49	20B434	CUP, drip, <i>includes 64</i>	1
11	2001659	SCREW, mach, slot hex washer hd.	8	50	19D873	PUMP, Displacement, small electric, <i>includes 51, 100</i>	1
12	19D292	COVER, motor	1	51	16N901	O-RING	2
13	20B440	MANIFOLD, fluid, <i>includes 14</i>	1	52	20B438	HOSE, suction, assembly, <i>includes 51, 55, 100</i>	1
14	117493	SCREW, mach, hex washer hd.	3	53	20B439	HOSE, coupled, <i>includes 54</i>	1
15	162453	FITTING, 1/4 NPSM x 1/4 NPT	1	54	16H137	O-RING	1
16	235014	KIT, replacement, valve, drain, <i>includes 17, 18, 19</i>	1	55	246385	STRAINER	1
17	224807	BASE, valve	1	57	19B596	HARNESSE, encoder	1
18	187625	HANDLE, valve, drain	1	59	See pg. 48	LABEL, brand, side	1
19	111600	PIN, grooved	1	60	See pg. 48	LABEL, brand, front upper	1
20	20B422	TRANSDUCER, pressure control, <i>includes 21, 28</i>	1	61	20B551	LABEL, Xtreme Torque	1
21	111457	PACKING, o-ring	1	62	19D678	LABEL, control	1
22	246384	FILTER, fluid, 60 mesh	1	64	19D788	SCREW, plastite, #10 hex wash hd.	1
23	117828	O-RING, PTFE, encapsulated	1	65	16D576	LABEL, made in USA	1
24	15B071	INSERT, filter	1	66	See pg. 48	LABEL, A+ service, Home Center	1
25	15G456	CAP, filter	1	76	114391	SCREW, grounding	2
26	276888	CLIP, drain line	1	79	241920	DEFLECTOR, threaded	1
27	246381	HOSE, drain, <i>includes 26, 79</i>	1	84	19D790	FAN, 5V DC, square	1
28	19C988	GROMMET, transducer	1	85	19D789	SCREW, plastite, #6 torx pan hd.	2
29	20B424	SHIELD, motor, side, painted, <i>includes 28, 34</i>	1	99	20B451	SCREW, hex hd.	2
30	20B425	POTENTIOMETER, encoder	1	100	117117	O-RING	1
31	2002370	KNOB, potentiometer, assembled, <i>includes 33, 62</i>	1	101	See pg. 48	LABEL, Xtreme Torque Advantage	1
32	19C527	HARNESSE, display/pot	1	102	See pg. 50	WIRE, jumper, (220-240V, 110V UK models only)	1
33	15C973	GASKET	1	103▲	2001766	LABEL, moving parts	1
34	19D307	SCREW, mach, torx pan hd.	7	104	See pg. 48	GUN	1
35	See pg. 48	FILTER	1	105	See pg. 48	HOSE	1
36	131172	SCREW, mach,	1				
37	2002366	SWITCH, rocker	1				
38		BOARD, control, assembly, <i>includes 76, 99</i>	1				
	20B427	100-120V					
	20B428	220-240V					

▲ Replacement safety labels, tags, and cards are available at no cost.

Lo-Boy Models 490 XT, 495 XT

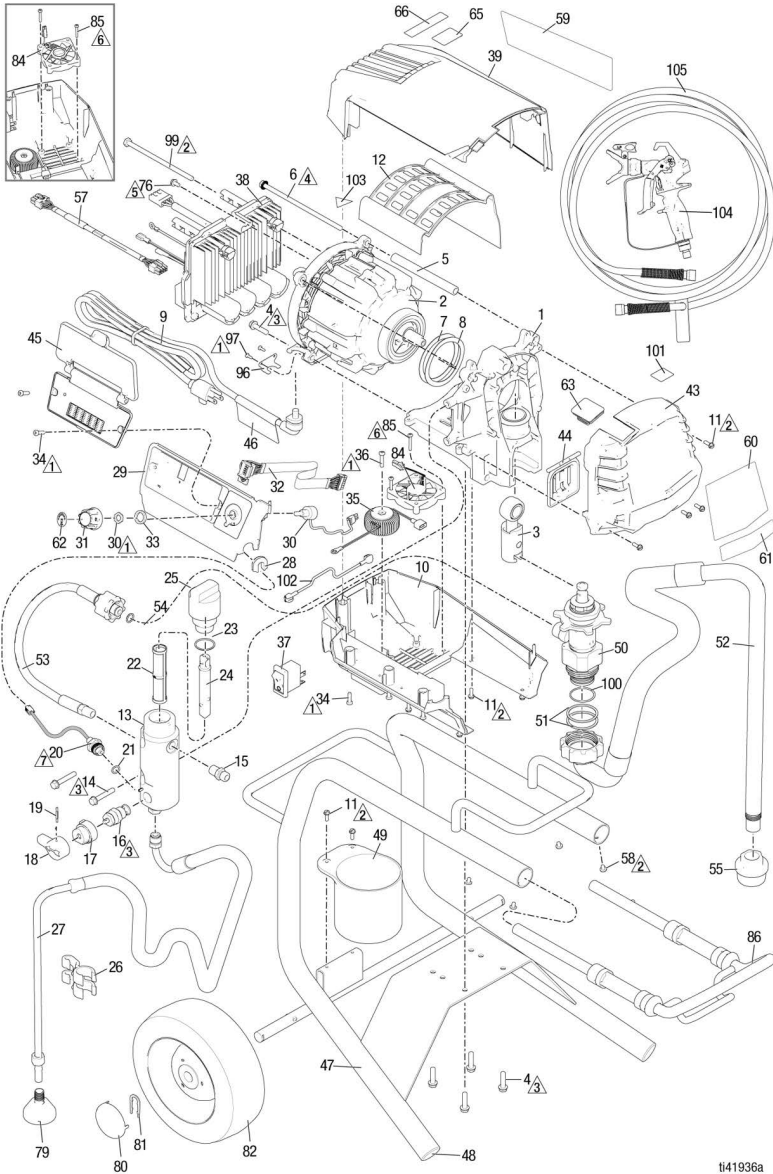

ti41936a

Ref.	Torque	Ref.	Torque	Ref.	Torque
1	12-16 in-lb (1.4-1.8 N•m)	4	70-75 in-lb (7.9-8.5 N•m)	7	37-43 ft-lb (50.2-58.3 N•m)
2	20-25 in-lb (2.3-2.8 N•m)	5	40-45 in-lb (4.5-5.1 N•m)		
3	140-160 in-lb (15.8-18.1 N•m)	6	8-10 in-lb (0.9-1.1 N•m)		

Lo-Boy Model Parts List 490 XT, 495 XT

Ref.	Part	Description	Qty.	Ref.	Part	Description	Qty.
1	20B413	HOUSING, pump with sleeve, <i>includes 4, 7, 8</i>	1	39	20B443	SHIELD, motor, top, painted, <i>includes 34</i>	1
2		MOTOR, Graco, XT, <i>includes 4, 5, 6, 7, 8</i>	1	43	20B430	COVER, front, painted, <i>includes 11</i>	1
	19C924	490		44	17C484	COVER, PC Pro pump rod	1
	19D860	495		45	20B431	MODULE, display only, <i>includes 34</i>	1
3	20B414	ROD, connecting, SM electrical assembly	1		20B432	MODULE, BlueLink w/ display, <i>includes 34</i>	1
4	20B534	SCREW, mach, hex washer hd.	6	46 ▲	See pg. 48	LABEL, warning, English, French, Spanish	1
5	20B415	SPACER, tie rod, motor, <i>includes 6</i>	2	47	19D424	FRAME, cart, Lo-Boy, <i>includes 48</i>	1
6	19C928	SCREW, cap, 1/4-20 x 6	2	48	107310	PLUG, leg	2
7	19C534	SPRING, wave washer	1	49	15B870	CUP, suction/drain	1
8	19C535	SHIM	1	50	19D873	PUMP, Displacement, small electric, <i>includes 51, 100</i>	1
9	See pg. 48	CORD, power, lighted, <i>includes 46</i>	1	51	16N901	O-RING	2
10	20B421	SHIELD, motor, bottom, <i>includes 11, 36, 37, 85</i>	1	52	20B438	HOSE, suction, assembly, <i>includes 51, 55, 100</i>	1
11	2001659	SCREW, mach, slot hex washer hd.	10	53	20B439	HOSE, coupled, <i>includes 54</i>	1
12	19D292	COVER, motor	1	54	16H137	O-RING	1
13	20B440	MANIFOLD, fluid, <i>includes 14, 15</i>	1	55	246385	STRAINER	1
14	117493	SCREW, mach, hex washer hd.	3	57	19B596	HARNESS, encoder	1
15	162453	FITTING, 1/4 NPSM x 1/4 NPT	1	58	109032	SCREW, mach, pan hd.	4
16	235014	KIT, replacement, valve, drain, <i>includes 17, 18, 19</i>	1	59	See pg. 48	LABEL, brand, side	1
17	224807	BASE, valve	1	60	See pg. 48	LABEL, brand, front upper	1
18	187625	HANDLE, valve, drain	1	61	20B551	LABEL, Xtreme Torque	1
19	111600	PIN, grooved	1	62	19D678	LABEL, control	1
20	20B422	TRANSDUCER, pressure control, <i>includes 21, 28</i>	1	63	19D261	PLUG, shroud, painted	1
21	111457	PACKING, o-ring	1	65	16D576	LABEL, made in USA	1
22	246384	FILTER, fluid, 60 mesh	1	66	See pg. 48	LABEL, A+ service, Home Center	1
23	117828	O-RING, PTFE, encapsulated	1	76	114391	SCREW, grounding	2
24	15B071	INSERT, filter	1	79	241920	DEFLECTOR, threaded	1
25	15G456	CAP, filter	1	80	104811	CAP, hub	2
26	276888	CLIP, drain line	1	81	15B999	CAP, retaining	2
27	246381	HOSE, drain, <i>includes 26, 79</i>	1	82	195766	WHEEL, semi-pneumatic	2
28	19C988	GROMMET, transducer	1	84	19D790	FAN, 5V DC, square	1
29	20B424	SHIELD, motor, side, painted, <i>includes 28, 34</i>	1	85	19D789	SCREW, plastite, #6 torx pan hd.	2
30	20B425	POTENTIOMETER, encoder, <i>includes 33</i>	1	86	19D794	HANDLE, Lo-Boy, assy.	1
31	2002370	KNOB, potentiometer, assembled, <i>includes 33, 62</i>	1	96*	20B514	BRACKET, strain relief	1
32	19C527	HARNESS, display/pot	1	97*	120593	SCREW, mach., torx	2
33	15C973	GASKET	1	99	20B451	SCREW, hex hd.	2
34	19D307	SCREW, mach, torx pan hd.	7	100	117117	O-RING	1
35	See pg. 48	FILTER	1	101	See pg. 48	LABEL, Xtreme Torque Advantage	1
36	131172	SCREW, mach,	1	102*	See pg. 50	WIRE, jumper, (240V and 110V UK models only)	1
37	2002366	SWITCH, rocker	1	103▲	2001766	LABEL, moving parts	1
38		BOARD, control, assembly, <i>includes 76, 99</i>	1	104	See pg. 48	GUN	1
	20B427	100-120V		105	See pg. 48	HOSE	1
	20B428	220-240V					

▲ Replacement safety labels, tags, and cards are available at no cost.

* Not included in all models.

Hi-Boy Models 490 XT, 495 XT

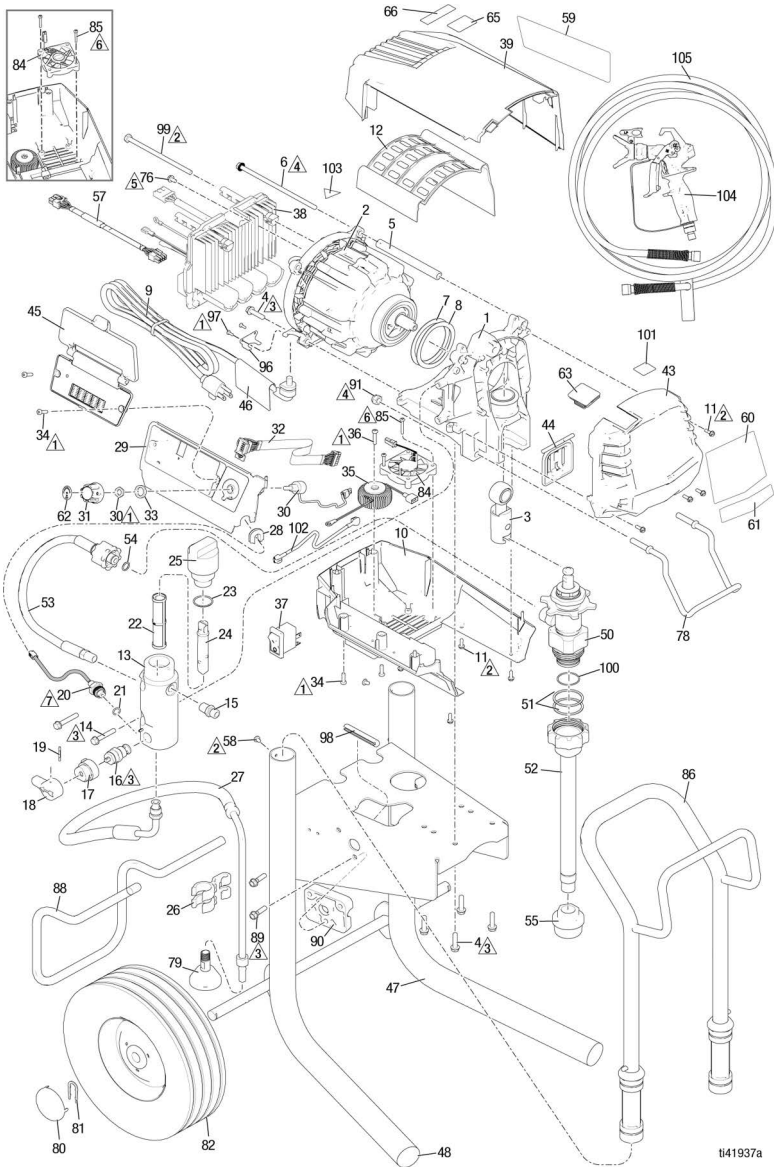

141937a

Ref.	Torque	Ref.	Torque	Ref.	Torque
△1	12-16 in-lb (1.4-1.8 N•m)	△4	70-75 in-lb (7.9-8.5 N•m)	△7	37-43 ft-lb (50.2-58.3 N•m)
△2	20-25 in-lb (2.3-2.8 N•m)	△5	40-45 in-lb (4.5-5.1 N•m)		
△3	140-160 in-lb (15.8-18.1 N•m)	△6	8-10 in-lb (0.9-1.1 N•m)		

Hi-Boy Model Parts List 490 XT, 495 XT

Ref.	Part	Description	Qty.	Ref.	Part	Description	Qty.
1	20B413	HOUSING, pump with sleeve, <i>includes 4, 7, 8</i>	1	43	20B430	COVER, front, painted, <i>includes 11</i>	1
2		MOTOR, Graco, XT, <i>includes 4, 5, 6, 7, 8</i>	1	44	17C484	COVER, PC Pro pump rod	1
	19C924	490		45	20B431	MODULE, display only, <i>includes 34</i>	1
	19D860	495			20B432	MODULE, BlueLink w/ display, <i>includes 34</i>	1
3	20B414	ROD, connecting, SM electrical assembly	1	46 ▲	See pg.48	LABEL, warning, English, French, Spanish	1
4	20B534	SCREW, mach, hex washer hd.	6	47	19D436	FRAME, cart, Hi-Boy, <i>includes 48</i>	1
5	20B415	SPACER, tie rod, motor, <i>includes 6</i>	2	48	108691	PLUG, tube	2
6	19C928	SCREW, cap, 1/4-20 x 6	2	50	19D873	PUMP, Displacement, small electric, <i>includes 51, 100</i>	1
7	19C534	SPRING, wave washer	1	51	16N901	O-RING	2
8	19C535	SHIM	1	52	20B299	TUBE, suction, assembly	1
9	See pg.48	CORD, power, lighted, <i>includes 46</i>	1	53	20B439	HOSE, coupled, <i>includes 54</i>	1
10	20B421	SHIELD, motor, bottom, <i>includes 11, 36, 37, 85</i>	1	54	16H137	O-RING	1
11	2001659	SCREW, mach, slot hex washer hd.	8	55	246385	STRAINER	1
12	19D292	COVER, motor	1	57	19B596	HARNESSE, encoder	1
13	20B440	MANIFOLD, fluid, <i>includes 14, 15</i>	1	58	109032	SCREW, mach, pan hd.	4
14	117493	SCREW, mach, hex washer hd.	3	59	See pg.48	LABEL, brand, side	1
15	162453	FITTING, 1/4 NPSM x 1/4 NPT	1	60	See pg.48	LABEL, brand, front upper	1
16	235014	KIT, replacement, valve, drain, <i>Includes 17, 18, 19</i>	1	61	20B551	LABEL, Xtreme Torque	1
17	224807	BASE, valve	1	62	19D678	LABEL, control	1
18	187625	HANDLE, valve, drain	1	63	19D261	PLUG, shroud, painted	1
19	111600	PIN, grooved	1	65	16D576	LABEL, made in USA	1
20	20B422	TRANSDUCER, pressure control, <i>includes 21, 28</i>	1	66	See pg.48	LABEL, A+ service, Home Center	1
21	111457	PACKING, o-ring	1	76	114391	SCREW, grounding	2
22	246384	FILTER, fluid, 60 mesh	1	78	2001457	HANGER, pail, threaded	1
23	117828	O-RING, PTFE, encapsulated	1	79	241920	DEFLECTOR, threaded	1
24	15B071	INSERT, filter	1	80	104811	CAP, hub	2
25	15G456	CAP, filter	1	81	15B999	CLIP, retaining	2
26	276888	CLIP, drain line	1	82	106062	WHEEL, semi-pneumatic	2
27	287952	HOSE, drain, Ultra, Hi-Boy, <i>includes 79</i>	1	84	19D790	FAN, 5V DC, square	1
28	19C988	GROMMET, transducer	1	85	19D789	SCREW, plastite, #6 torx pan hd.	2
29	20B424	SHIELD, motor, side, painted, <i>includes 28, 34</i>	1	86	287489	HANDLE, assy., Hi-Cart	1
30	20B425	POTENTIOMETER, encoder, <i>includes 33</i>	1	88	15D281	HANGER, stand, cart	1
31	2002370	KNOB, potentiometer, assembled, <i>includes 33, 62</i>	1	89	114531	SCREW, mach, hex washer hd.	4
32	19C527	HARNESSE, display/pot	1	90	15C982	CAM, cart	2
33	15C973	GASKET	1	91	111040	NUT, lock, insert, Nylock, 5/16	2
34	19D307	SCREW, mach, torx pan hd.	7	96*	20B514	BRACKET, strain relief	1
35	See pg. 48	COIL, filter, <i>includes 36, 76</i>	1	97*	120593	SCREW, mach., torx	2
36	131172	SCREW, mach,	1	98	20B541	TRIM, edge	1
37	2002366	SWITCH, rocker	1	99	20B451	SCREW, hex hd.	2
38		BOARD, control, assembly, <i>includes 76</i>	1	100	117117	O-RING	1
	20B427	100-120V		101	See pg.48	LABEL, Xtreme Torque Advantage	1
	20B428	220-240V		102*	See pg.50	WIRE, jumper, (220-240V, 110V UK models only)	1
	2002367	110V UK		103▲	2001766	LABEL, moving parts	1
39	20B443	SHIELD, motor, top, painted, <i>includes 34</i>	1	104	See pg.48	GUN	1
				105	See pg.48	HOSE	1

▲ Replacement safety labels, tags, and cards are available at no cost.

* Not included in all models.

Lo-Boy Model 650 XT

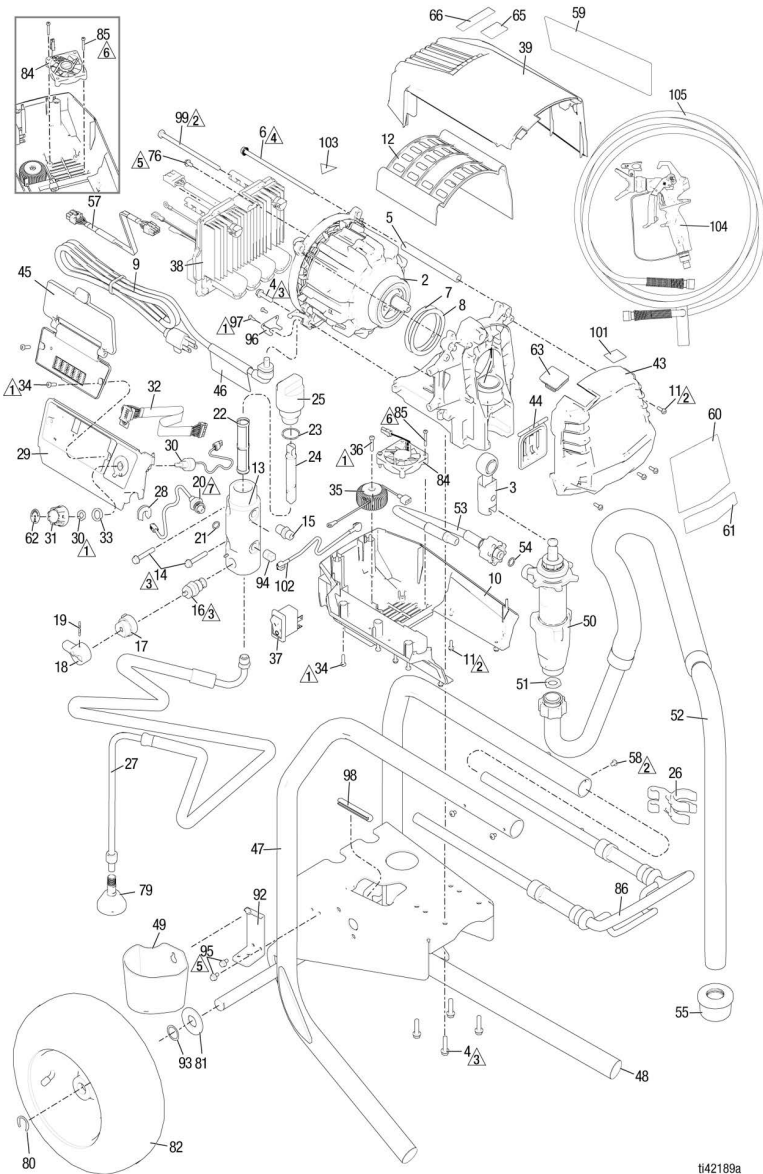

tt42189a

Lo-Boy Model Parts List 650 XT

Ref.	Part	Description	Qty.	Ref.	Part	Description	Qty.
1	20B413	HOUSING, pump with sleeve, <i>includes 4, 7, 8</i>	1	43	20B430	COVER, front, painted, <i>includes 11</i>	1
2	19C925	MOTOR, Graco, XT, <i>includes 1, 3, 4, 5, 6, 7, 8</i>	1	44	17C484	COVER, PC Pro pump rod	1
3	20B414	ROD, connecting, SM electrical assembly	1	45	20B431	MODULE, display only, <i>includes 34</i>	1
4	20B534	SCREW, mach, hex washer hd.	6		20B432	MODULE, BlueLink w/ display, <i>includes 34</i>	1
5	20B415	SPACER, tie rod, motor, <i>includes 6</i>	2	46 ▲	See pg.48	LABEL, warning, English, French, Spanish	1
6	19C928	SCREW, cap, 1/4-20 x 6	2	47	20B204	FRAME, cart, Lo-Boy, <i>includes 48</i>	1
7	19C534	SPRING, wave washer	1	48	107310	CAP, leg	2
8	19C535	SHIM	1	49	276975	CUP, suction/drain	1
9	See pg.48	CORD, power, lighted, <i>includes 46</i>	1	50	2002382	PUMP, Displacement, small electric	1
10	20B421	SHIELD, motor, bottom, <i>includes 11, 36, 37, 85</i>	1	51	115099	WASHER	1
11	2001659	SCREW, mach, slot hex washer hd.	8	52	248216	HOSE, suction, assembly, <i>includes 51</i>	1
12	19D292	COVER, motor	1	53	20B439	HOSE, coupled, <i>includes 54</i>	1
13	20B441	MANIFOLD, fluid, <i>includes 14, 15, 94</i>	1	54	16H137	O-RING	1
14	117493	SCREW, mach, hex washer hd.	3	55	189920	STRAINER	1
15	162453	FITTING, 1/4 NPSM x 1/4 NPT	1	57	19B596	HARNESS, encoder	1
16	235014	KIT, replacement, valve, drain, <i>includes 17, 18, 19</i>	1	58	19032	SCREW, mach, pan hd.	4
17	224807	BASE, valve	1	59	See pg.48	LABEL, brand, side	1
18	187625	HANDLE, valve, drain	1	60	See pg.48	LABEL, brand, front upper	1
19	111600	PIN, grooved	1	61	20B551	LABEL, Xtreme Torque	1
20	20B422	TRANSDUCER, pressure control, <i>includes 21, 28</i>	1	62	19D678	LABEL, control	1
21	111457	PACKING, o-ring	1	63	19D261	PLUG, shroud, painted	1
22	246384	FILTER, fluid, 60 mesh	1	65	16D576	LABEL, made in USA	1
23	117828	O-RING, PTFE, encapsulated	1	66	See pg.48	LABEL, A+ service, Home Center	1
24	15B071	INSERT, filter	1	76	114391	SCREW, grounding	2
25	15G456	CAP, filter	1	79	241920	DEFLECTOR, threaded	1
26	15D000	CLIP, drain line	1	80	15E891	CLIP, retaining	2
27	248217	HOSE, drain, <i>includes 79</i>	1	81	156306	WASHER	2
28	19C988	GROMMET, transducer	1	82	119420	WHEEL, semi-pneumatic	2
29	20B424	SHIELD, motor, side, painted, <i>includes 28, 34</i>	1	84	19D790	FAN, 5V DC, square	1
30	20B425	POTENTIOMETER, encoder, <i>includes 33</i>	1	85	19D789	SCREW, plastite, #6 torx pan hd.	2
31	2002370	KNOB, potentiometer, assembled, <i>includes 33, 62</i>	1	86	19D794	HANDLE, Lo-Boy, assy.	1
32	19C527	HARNESS, display/pot	1	92	15F952	BRACKET	1
33	15C973	GASKET	1	93	116038	WASHER, spring	2
34	19D307	SCREW, mach, torx pan hd.	7	94	100509	PLUG, pipe	1
35	See pg. 48	COIL, filter, <i>includes 36, 76</i>	1	95	114423	SCREW	1
36	131172	SCREW, mach,	1	96	20B514	BRACKET, strain relief	1
37	2002366	SWITCH, rocker	1	97	120593	SCREW, mach, torx	2
38		BOARD, control, assembly, <i>includes 76, 99</i>	1	98	20B541	TRIM, edge	1
	20B427	110-120V		99	20B451	SCREW, hex hd.	2
	20B428	220-240V		101	See pg.48	LABEL, Xtreme Torque Advantage	1
39	20B443	SHIELD, motor, top, painted, <i>includes 34</i>	1	102	See pg.50	WIRE, jumper, (220-240V, 110V UK models only)	1
				103▲	2001766	LABEL, moving parts	1
				104	See pg.48	GUN	1
				105	See pg.48	HOSE	1

▲ Replacement safety labels, tags, and cards are available at no cost.

Hi-Boy Models 650 XT

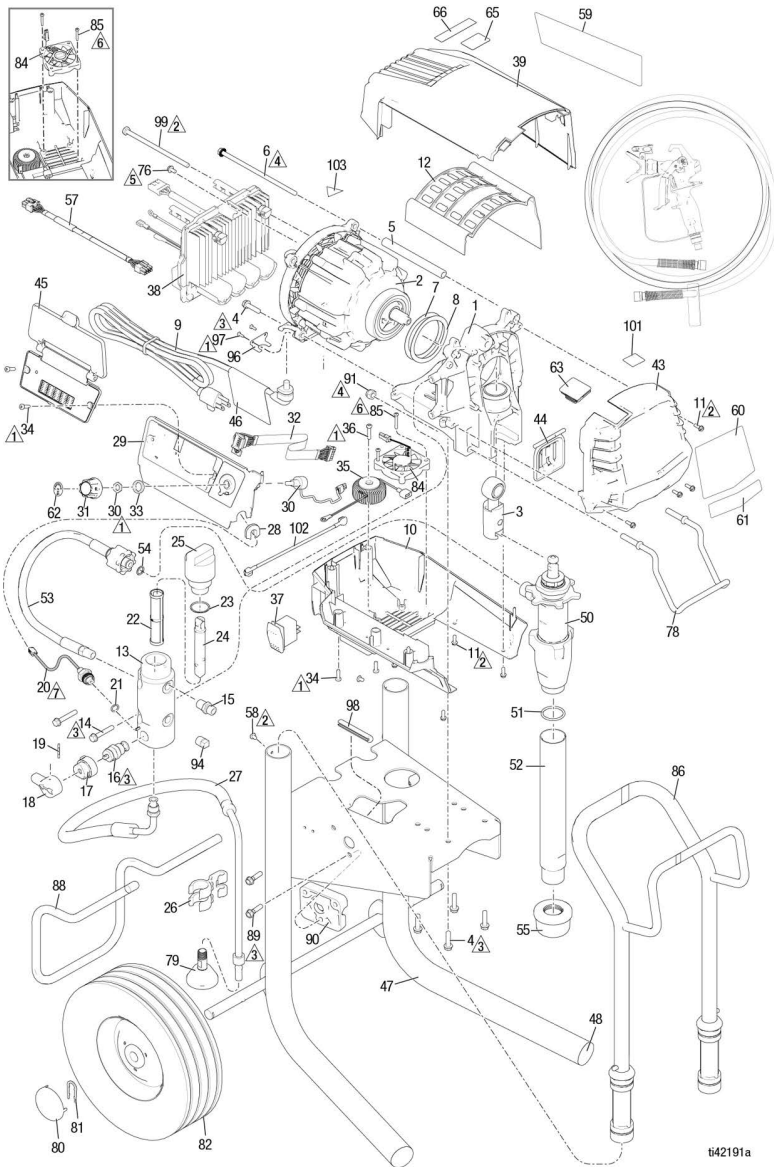

Ref.	Torque	Ref.	Torque	Ref.	Torque
▲1	12-16 in-lb (1.4-1.8 N•m)	▲4	70-75 in-lb (7.9-8.5 N•m)	▲7	37-43 ft-lb (50.2-58.3 N•m)
▲2	20-25 in-lb (2.3-2.8 N•m)	▲5	40-45 in-lb (4.5-5.1 N•m)		
▲3	140-160 in-lb (15.8-18.1 N•m)	▲6	8-10 in-lb (0.9-1.1 N•m)		

Hi-Boy Model Parts List 650 XT

Ref.	Part	Description	Qty.	Ref.	Part	Description	Qty.
1	20B413	HOUSING, pump with sleeve, <i>includes 4, 7, 8</i>	1	43	20B430	COVER, front, painted, <i>includes 11</i>	1
2	19C925	MOTOR, Graco, XT, <i>includes 1, 3, 4, 5, 6, 7, 8</i>	1	44	17C484	COVER, PC Pro pump rod	1
3	20B414	ROD, connecting, SM electrical assembly	1	45	20B431	MODULE, display only, <i>includes 34</i>	1
4	20B534	SCREW, mach, hex washer hd.	6		20B432	MODULE, BlueLink w/ display, <i>includes 34</i>	1
5	20B415	SPACER, tie rod, motor, <i>includes 6</i>	2	46 ▲	See pg.48	LABEL, warning, English, French, Spanish	1
6	19C928	SCREW, cap, 1/4-20 x 6	2	47	19D436	FRAME, cart, Hi-Boy, <i>includes 48</i>	1
7	19C534	SPRING, wave washer	1	48	108691	PLUG, tube	2
8	19C535	SHIM	1	50	2002382	PUMP, Displacement, small electric	1
9	See pg.48	CORD, power, lighted, <i>includes 46, 96, 97</i>	1	51	118494	O-RING	1
10	20B421	SHIELD, motor, bottom, <i>includes 11, 36, 37, 85</i>	1	52	19D856	TUBE, suction	1
11	2001659	SCREW, mach, slot hex washer hd.	8	53	20B439	HOSE, coupled, <i>includes 54</i>	1
12	19D292	COVER, motor	1	54	16H137	O-RING	1
13	20B441	MANIFOLD, fluid, <i>includes 14, 15, 94</i>	1	55	189920	STRAINER	1
14	117493	SCREW, mach, hex washer hd.	3	57	19B596	HARNESSE, encoder	1
15	162453	FITTING, 1/4 NPSM x 1/4 NPT	1	58	109032	SCREW, mach, pan hd.	4
16	235014	KIT, replacement, valve, drain, <i>includes 17, 18, 19</i>	1	59	See pg.48	LABEL, brand, side	1
17	224807	BASE, valve	1	60	See pg.48	LABEL, brand, front upper	1
18	187625	HANDLE, valve, drain	1	61	20B551	LABEL, Xtreme Torque	1
19	111600	PIN, grooved	1	62	19D678	LABEL, control	1
20	20B422	TRANSDUCER, pressure control, <i>includes 21, 28</i>	1	63	19D261	PLUG, shroud, painted	1
21	111457	PACKING, o-ring	1	65	16D576	LABEL, made in USA	1
22	246384	FILTER, fluid, 60 mesh	1	66	See pg.48	LABEL, A+ service, Home Center	1
23	117828	O-RING, PTFE, encapsulated	1	76	114391	SCREW, grounding	2
24	15B071	INSERT, filter	1	78	2001457	HANGER, pail, threaded	1
25	15G456	CAP, filter	1	79	241920	DEFLECTOR, threaded	1
26	15D000	CLIP, drain line	1	80	104811	CAP, hub	2
27	287952	HOSE, drain, Ultra Hi-Boy, <i>includes 79</i>	1	81	15B999	CLIP, retaining	2
28	19C988	GROMMET, transducer	1	82	106062	WHEEL, semi-pneumatic	2
29	20B424	SHIELD, motor, side, painted, <i>includes 28, 34</i>	1	84	19D790	FAN, 5V DC, square	1
30	20B425	POTENTIOMETER, encoder, <i>includes 33</i>	1	85	19D789	SCREW, plastite, #6 torx pan hd.	2
31	2002370	KNOB, potentiometer, assembled, <i>includes 33, 62</i>	1	86	287489	HANDLE, assy., Hi-Cart	1
32	19C527	HARNESSE, display/pot	1	88	15D281	HANGER, stand, cart	1
33	15C973	GASKET	1	89	114531	SCREW, mach, hex washer hd.	4
34	19D307	SCREW, mach, torx pan hd.	7	90	15C982	CAM, cart	2
35	See pg. 48	COIL, filter, <i>includes 36, 76</i>	1	91	111040	NUT, lock, insert, Nylock, 5/16	2
36	131172	SCREW, mach,	1	94	100509	PLUG, pipe	1
37	2002366	SWITCH, rocker	1	96	20B514	BRACKET, strain relief	1
38		BOARD, control, assembly, <i>includes 76, 99</i>	1	97	120593	SCREW, mach, torx	2
	20B427	110-120V		98	20B541	TRIM, edge	1
	20B428	220-240V		99	20B451	SCREW, hex hd.	2
	2002367	110V UK		101	See pg.48	LABEL, Xtreme Torque Advantage	1
39	20B443	SHIELD, motor, top, painted, <i>includes 34</i>	1	102	See pg.50	WIRE, jumper, (220V-240V, 110V UK models only)	1
				103▲	2001766	LABEL, moving parts	1
				104	See pg.48	GUN	1
				105	See pg.48	HOSE	1

▲ Replacement safety labels, tags, and cards are available at no cost.

Accessories and Labels

Accessories and Labels

Sprayer Model Number	Ref. 9 Power Cord	Ref. 46 Warning Label ▲	Hose	Gun	Medical Label ▲	Ref. 66 A+ Service Label	Ref. 60 Front Label	Ref. 59 Side Label	Ref. 35 Line Filter	Ref. 101 Top Label		
826284, 826285, 826286	20B420	19D674	826079	826291	222385	17P924	826302	826305	20B426	2004240		
826287							826303	826306				
826288, 826289	20B580						826304	826307				
826293, 826294							19D734	19D738				
19D519, 19D520, 19D521	20B420		19D735	19D739								
19D522	20B580		17P924	19D737			19D741					
19D523, 19D524			19D734	19D738		19C991						
20B304, 20B305	19D674		240794	17Y043			17P925	19D735	19D739	25V601	20B552	
19D525, 19D526	20B416					16G596		17A134	19D734	19D738		19C991
19D527, 19D528									20B419	19D675		19D735
19D529, 19D530	20B418	19D677			26A998	19D734		19D738				20B426
19D531				20B581		16G596		222385	19D735	19D739		19C991
19D532, 19D533, 19D534	20B416	17A134			17P925				19D737	19D741		19C991
19D535				20B419		17A134	19D737	19D735	19D739	25V601		
19D536	20B418	19d675			17A134			19D737	19D741	19C991		
20B308				20B327		20B328	20B328	19D737	19D741	19C991		
20B311	19D737	19D741			19C991							
20B327	19D737	19D741	19C991									
20B328	19D737	19D741	19C991									

▲ Replacement safety labels, tags, and cards are available at no cost.

Wiring Diagrams

110-120V

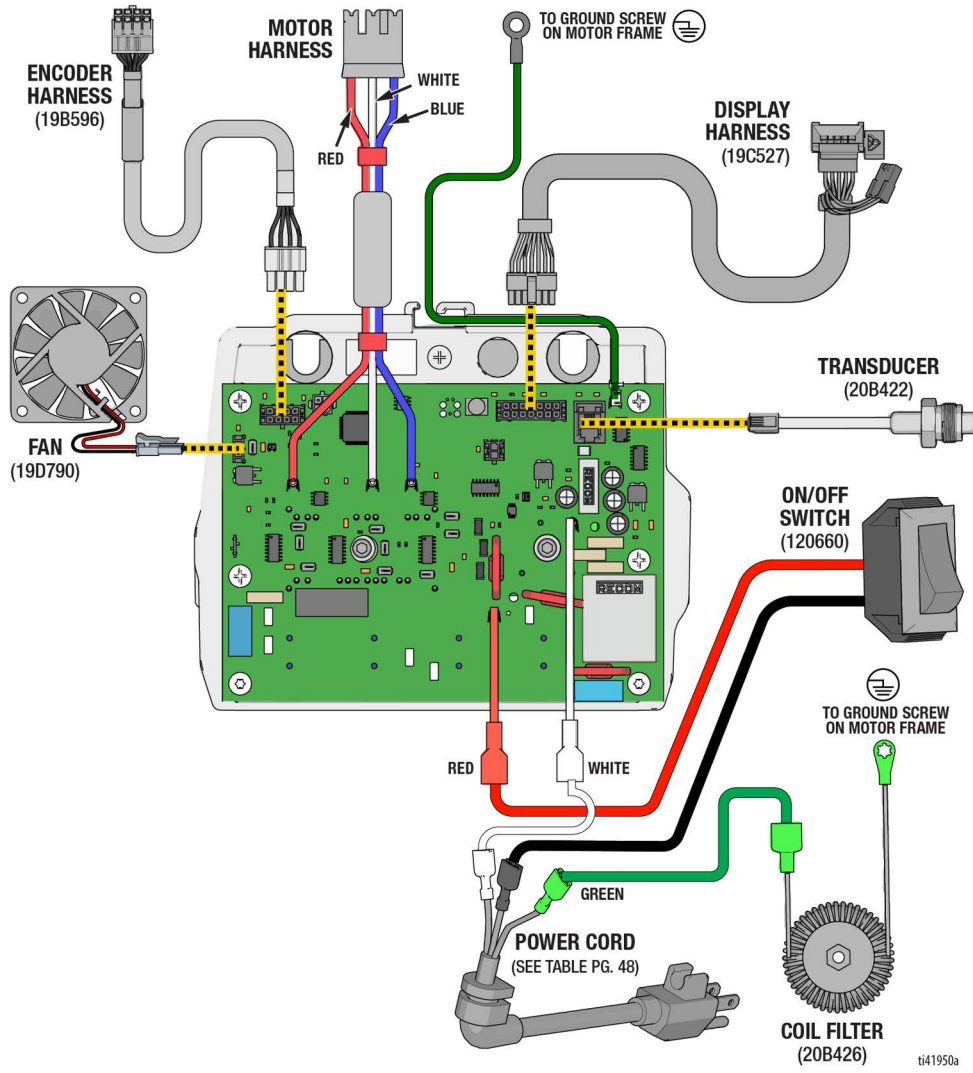

t41950a

Wiring Diagrams

220-240V

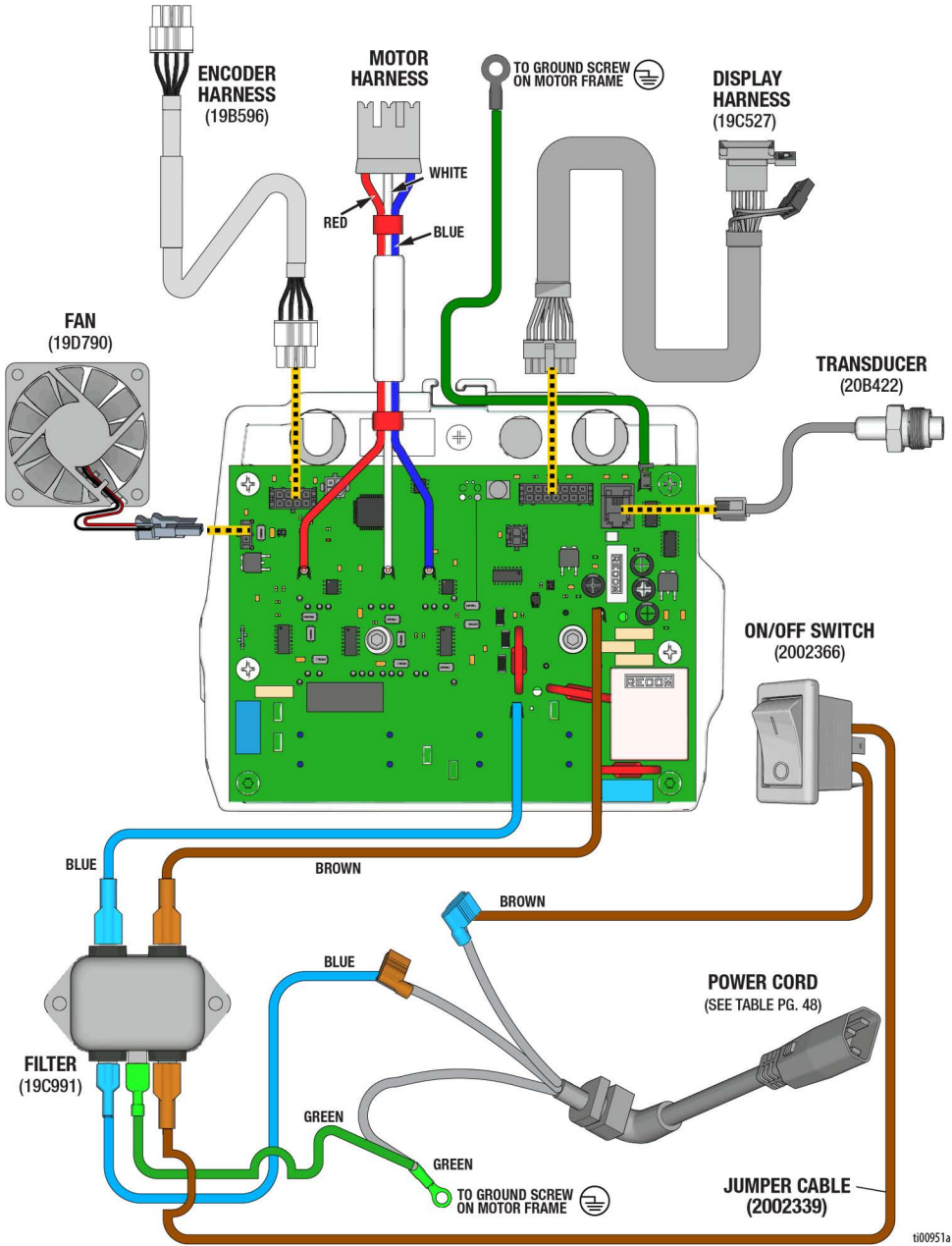

t00951a

110V UK

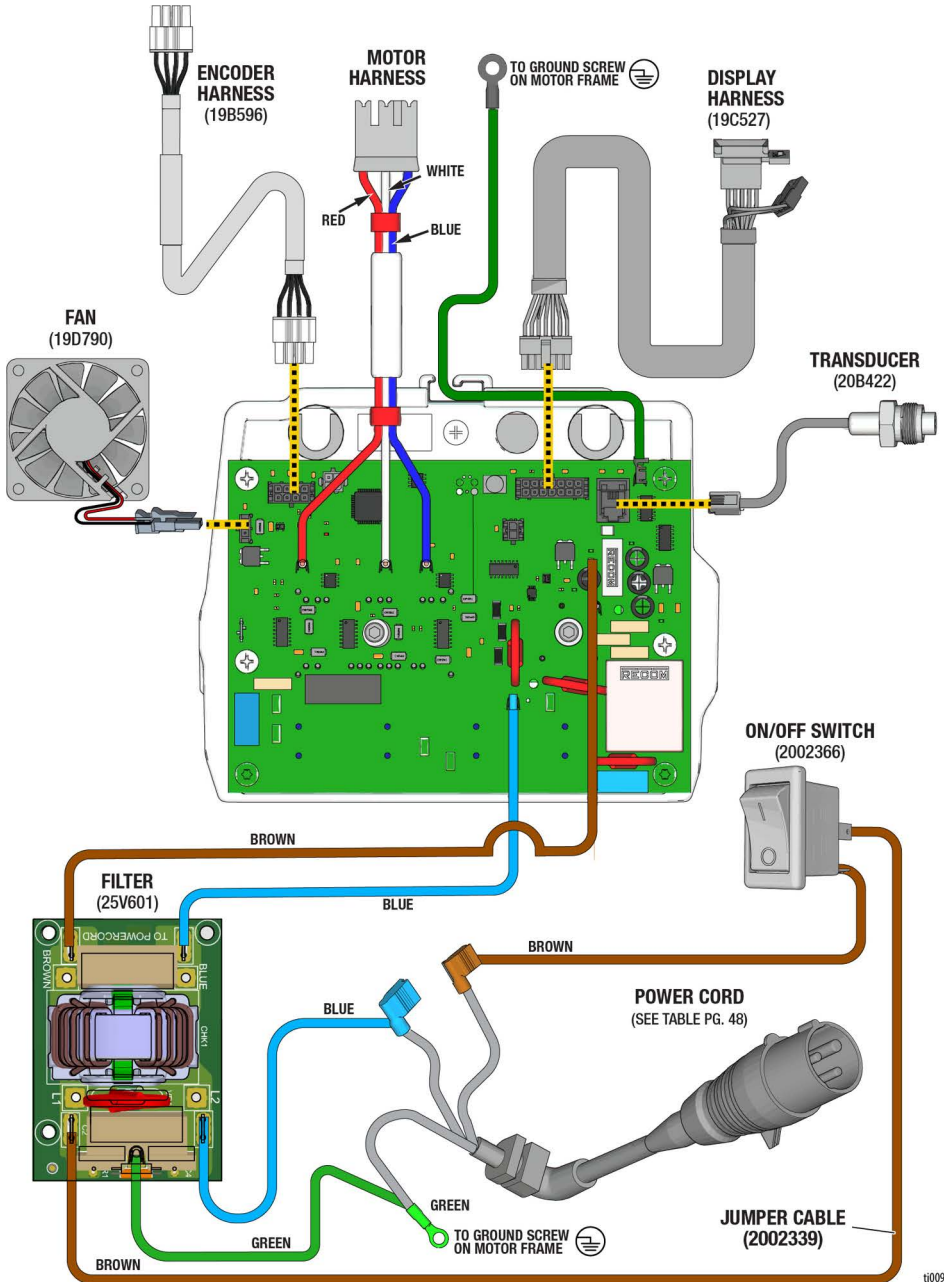

t00934a

Technical Specifications

Technical Specifications

Sprayer	US	Metric
Maximum Fluid Working Pressure*	3300 psi	228 bar, 22.8 MPa
Maximum Delivery		
490	0.7 gpm	2.6 lpm
495	0.8 gpm	3.0 lpm
650	0.9 gpm	3.4 lpm
Maximum Tip Size (Model)	0.025 (490), 0.027 (495), 0.029 (650)	
Fluid Outlet npsm	1/4 in.	
Cycles*		
490, 495	700 per gallon	185 per liter
650	570 per gallon	150 per liter
Generator Minimum	3500 W	
Power Requirements		
490	100–120V, 12.4 A; 220/240V, 9A	
495	100–120V, 13 A; 220/240V, 9A	
650	100–120V, 15 A; 220/240V, 10A	
Ambient Temperature Limits		
Operation	30° - 115°F	0° - 46°C
Storage	-30° - 160°F	-35° - 71°C
Dimensions - Stand		
Height	17.8 in.	45.2 cm
Length	16.4 in.	41.7 cm
Width	13.4 in.	34 cm
Weight	31 lb.	14.1 kg
Dimensions - Lo Boy (490, 495)		
Height	22.2 in.	56.4 cm
Length	25.3 in.	64.3 cm
Width	19.8 in.	50.3 cm
Weight	56 lb.	25.4 kg
Dimensions - Lo Boy (650)		
Height	28 in.	71.1 cm
Length	29.5 in.	75 cm
Width	22.3 in.	56.6 cm
Weight	68 lb.	30.8 kg
Dimensions - Hi Boy		
Height	28.6 in.	72.6 cm
Length	22.2 in.	56.4 cm
Width	20.5 in.	52.1 cm
Weight (490, 495)	66 lb.	29.9 kg
Weight (650)	69 lb.	31.3 kg
Noise** (dBa) @ 70 psi (0.48 MPa, 4.8 bar)		
Sound Pressure	490/495 = 75 dBa, 650 = 78 dBa	
Sound Power	490/495 = 87 LwA, 650 = 92 LwA	
Materials of Construction		
Wetted materials on all models	Zinc- and nickel-plated carbon steel, nylon, stainless steel, PTFE, acetal, leather, UHMWPE, aluminum, tungsten carbide, polyethylene, fluoroelastomer, urethane	
Notes		
* Startup pressures and displacement per cycle may vary based on suction condition, discharge head, air pressure, and fluid type.		
** Sound pressure measured 3 feet (1 meter) from equipment.		
** Sound power measured per ISO-3744.		
All trademarks or registered trademarks are the property of their respective owners.		

Technical Specifications

Graco Date Code					
Graco Date Code/Serial Code	Month (First Character)	Year (2nd and 3rd Characters)	Series (4th Character)	Part Number (5th-10th Characters)	Series (11th-16th Characters)
Example Date Code: A16A	A = January	16 = 2016	A = Serial Control Number		
Example Date Code: L16A232749000102	L = December	16 = 2016	A = Serial Control Number	6 digit alphanumeric part number	6 digit sequential serial number

California Proposition 65

CALIFORNIA RESIDENTS

 **WARNING:** Cancer and reproductive harm – www.P65warnings.ca.gov.

Graco Standard Warranty

Graco Standard Warranty

Graco warrants all equipment referenced in this document which is manufactured by Graco and bearing its name to be free from defects in material and workmanship on the date of sale to the original purchaser for use. With the exception of any special, extended, or limited warranty published by Graco, Graco will, for a period of twelve months from the date of sale, repair or replace any part of the equipment determined by Graco to be defective. This warranty applies only when the equipment is installed, operated and maintained in accordance with Graco's written recommendations.

This warranty does not cover, and Graco shall not be liable for general wear and tear, or any malfunction, damage or wear caused by faulty installation, misapplication, abrasion, corrosion, inadequate or improper maintenance, negligence, accident, tampering, or substitution of non-Graco component parts. Nor shall Graco be liable for malfunction, damage or wear caused by the incompatibility of Graco equipment with structures, accessories, equipment or materials not supplied by Graco, or the improper design, manufacture, installation, operation or maintenance of structures, accessories, equipment or materials not supplied by Graco.

This warranty is conditioned upon the prepaid return of the equipment claimed to be defective to an authorized Graco distributor for verification of the claimed defect. If the claimed defect is verified, Graco will repair or replace free of charge any defective parts. The equipment will be returned to the original purchaser transportation prepaid. If inspection of the equipment does not disclose any defect in material or workmanship, repairs will be made at a reasonable charge, which charges may include the costs of parts, labor, and transportation.

THIS WARRANTY IS EXCLUSIVE, AND IS IN LIEU OF ANY OTHER WARRANTIES, EXPRESS OR IMPLIED, INCLUDING BUT NOT LIMITED TO WARRANTY OF MERCHANTABILITY OR WARRANTY OF FITNESS FOR A PARTICULAR PURPOSE.

Graco's sole obligation and buyer's sole remedy for any breach of warranty shall be as set forth above. The buyer agrees that no other remedy (including, but not limited to, incidental or consequential damages for lost profits, lost sales, injury to person or property, or any other incidental or consequential loss) shall be available. Any action for breach of warranty must be brought within two (2) years of the date of sale.

GRACO MAKES NO WARRANTY, AND DISCLAIMS ALL IMPLIED WARRANTIES OF MERCHANTABILITY AND FITNESS FOR A PARTICULAR PURPOSE, IN CONNECTION WITH ACCESSORIES, EQUIPMENT, MATERIALS OR COMPONENTS SOLD BUT NOT MANUFACTURED BY GRACO. These items sold, but not manufactured by Graco (such as electric motors, switches, hose, etc.), are subject to the warranty, if any, of their manufacturer. Graco will provide purchaser with reasonable assistance in making any claim for breach of these warranties.

In no event will Graco be liable for indirect, incidental, special or consequential damages resulting from Graco supplying equipment hereunder, or the furnishing, performance, or use of any products or other goods sold hereto, whether due to a breach of contract, breach of warranty, the negligence of Graco, or otherwise.

FOR GRACO CANADA CUSTOMERS

The Parties acknowledge that they have required that the present document, as well as all documents, notices and legal proceedings entered into, given or instituted pursuant hereto or relating directly or indirectly hereto, be drawn up in English. Les parties reconnaissent avoir convenu que la rédaction du présente document sera en Anglais, ainsi que tous documents, avis et procédures judiciaires exécutés, donnés ou intentés, à la suite de ou en rapport, directement ou indirectement, avec les procédures concernées.

Graco Information

For the latest information about Graco products, visit www.graco.com.

For patent information, see www.graco.com/patents.

TO PLACE AN ORDER, contact your Graco distributor or call 1-800-690-2894 to identify the nearest distributor.



All written and visual data contained in this document reflects the latest product information available at the time of publication.

Graco reserves the right to make changes at any time without notice.

Original instructions. This manual contains English. MM 3A9095

Graco Headquarters: Minneapolis

International Offices: Belgium, China, Japan, Korea

GRACO INC. AND SUBSIDIARIES • P.O. BOX 1441 • MINNEAPOLIS MN 55440-1441 • USA

Copyright 2023, Graco Inc. All Graco manufacturing locations are registered to ISO 9001.

www.graco.com

Revision D, March 2024